



Surgery . Orthopaedic . Laminectomy

	Seite · Page
Laminektomie-Stanzen <i>Laminectomy-Rongeurs</i>	5 – 19
Intervertebral-Rongeure <i>Intervertebral-Rongeurs</i>	21 – 25
Arbeitsteil <i>Jaws</i>	26
Hohlmeisselzangen <i>Bone Rongeurs</i>	28 – 40
Knochensplitterzangen <i>Bone Cutting Forceps</i>	41 – 45
Knochenhaltezangen <i>Bone Holding Forceps</i>	46
Flachzangen <i>Flate Nose Pliers</i>	47
TC-Drahtschneidezangen <i>TC Wire Cutting Pliers</i>	48 – 50
Drahtschneidezangen <i>Wire Cutting Pliers</i>	5 – 19
Nadelhalter <i>Needle Holders</i>	51
Bolzenschneider <i>Pin- and Rod Cutters</i>	52
Hämmer & Meissel <i>Hammer & Chisel</i>	54
Wundhaken, Knochenhebel & Elevatoren <i>Retractors, Bone Levers & Elevators</i>	55

PROTOTYPES *Custom-made*

Individually made for **our customers**

Alle unsere **Prototypen** werden individuell nach Kundenwunsch konstruiert und angefertigt.

Wir helfen Ihnen gerne bei der Umsetzung ihres eigenen Instruments. Grundsätzlich können wir fast alle Kundenwünsche umsetzen.

Kommen Sie auf uns zu!

*All our **prototypes** are designed and manufactured according to our customers specifications.*

Our technical staff may help you to realize your own design. We basically can meet all our customer demands.

Please contact us!

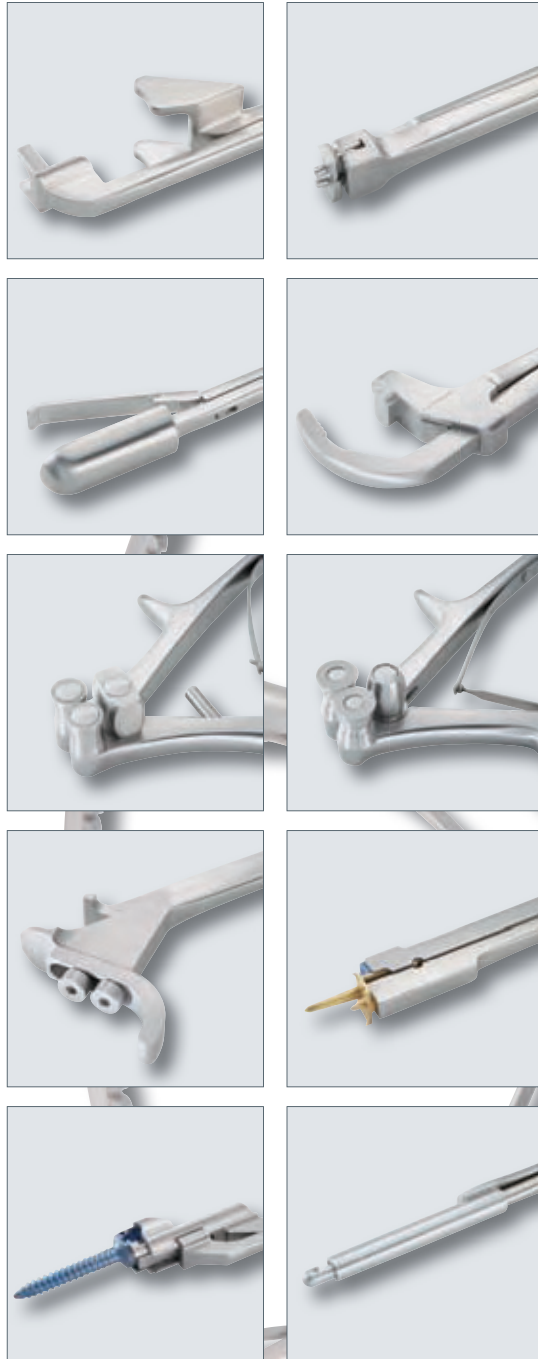

TITANIUM Instruments

Individually made for **our customers**

Wir können alle unseren gängigen Instrumente auch aus Titan herstellen.

Titaninstrumente sind vor allem bei Operationen unter dem Magnetfeld (MRI) von großem Vorteil. Sie zeichnen sich durch ein geringeres Gewicht und eine bessere Standfestigkeit aus.

All our current instruments can also be manufactured out of titanium.

Titanium instruments are necessary for use in the Magnetic Resonance Imaging (MRI) field. They are light in weight and hold higher resistance against corrosion.

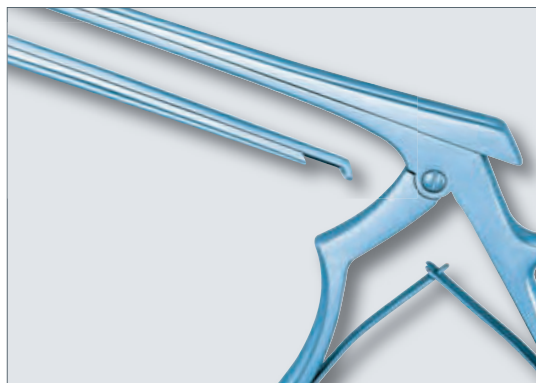
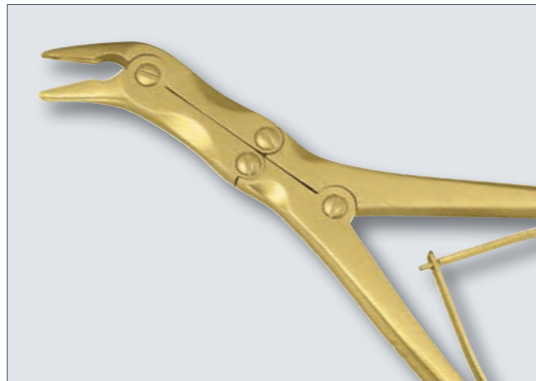

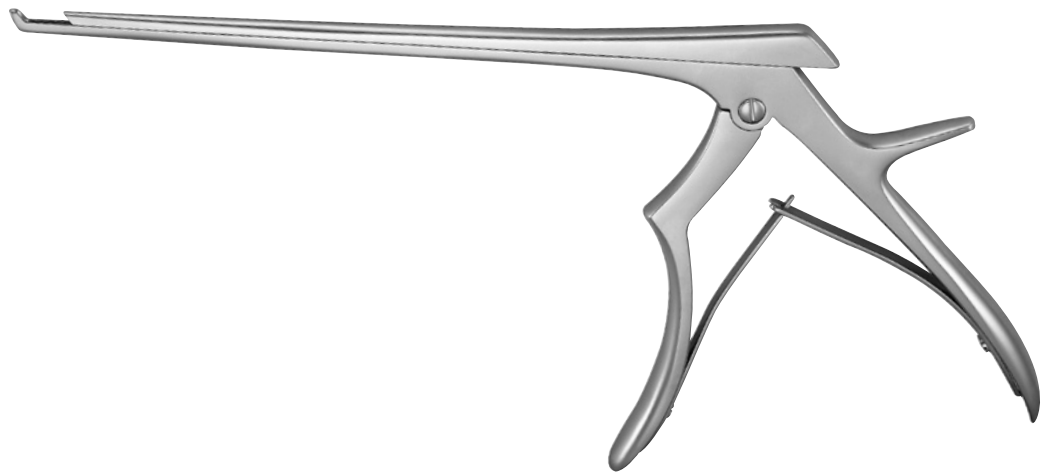

FERRIS-SMITH-KERRISON

1 mm 2 mm 3 mm 4 mm 5 mm 6 mm

aufwärts schneidend up bite	Schaftlänge length of shaft	Bestell-Nr. Ordering No.	Bestell-Nr. Ordering No.	Bestell-Nr. Ordering No.	Bestell-Nr. Ordering No.	Bestell-Nr. Ordering No.	Bestell-Nr. Ordering No.
	15 cm / 6 inch	45-035.01	45-035.02	45-035.03	45-035.04	45-035.05	45-035.06
	18 cm / 7 inch	45-040.01	45-040.02	45-040.03	45-040.04	45-040.05	45-040.06
	20 cm / 8 inch	45-045.01	45-045.02	45-045.03	45-045.04	45-045.05	45-045.06
	30 cm / 12 inch	45-046.01	45-046.02	45-046.03	45-046.04	45-046.05	45-046.06

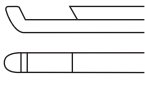
40° vorwärts schneidend 40° cutting forward	Schaftlänge length of shaft	Bestell-Nr. Ordering No.	Bestell-Nr. Ordering No.	Bestell-Nr. Ordering No.	Bestell-Nr. Ordering No.	Bestell-Nr. Ordering No.	Bestell-Nr. Ordering No.
	15 cm / 6 inch	45-050.01	45-050.02	45-050.03	45-050.04	45-050.05	45-050.06
	18 cm / 7 inch	45-055.01	45-055.02	45-055.03	45-055.04	45-055.05	45-055.06
	20 cm / 8 inch	45-060.01	45-060.02	45-060.03	45-060.04	45-060.05	45-060.06
	30 cm / 12 inch	45-061.01	45-061.02	45-061.03	45-061.04	45-061.05	45-061.06

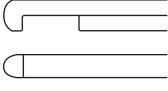
abwärts schneidend down bite	Schaftlänge length of shaft	Bestell-Nr. Ordering No.	Bestell-Nr. Ordering No.	Bestell-Nr. Ordering No.	Bestell-Nr. Ordering No.	Bestell-Nr. Ordering No.	Bestell-Nr. Ordering No.
	15 cm / 6 inch	45-065.01	45-065.02	45-065.03	45-065.04	45-065.05	45-065.06
	18 cm / 7 inch	45-070.01	45-070.02	45-070.03	45-070.04	45-070.05	45-070.06
	20 cm / 8 inch	45-075.01	45-075.02	45-075.03	45-075.04	45-075.05	45-075.06
	30 cm / 12 inch	45-076.01	45-076.02	45-076.03	45-076.04	45-076.05	45-076.06

▶ andere Schaftlängen auf Anfrage
other shaft sizes upon request

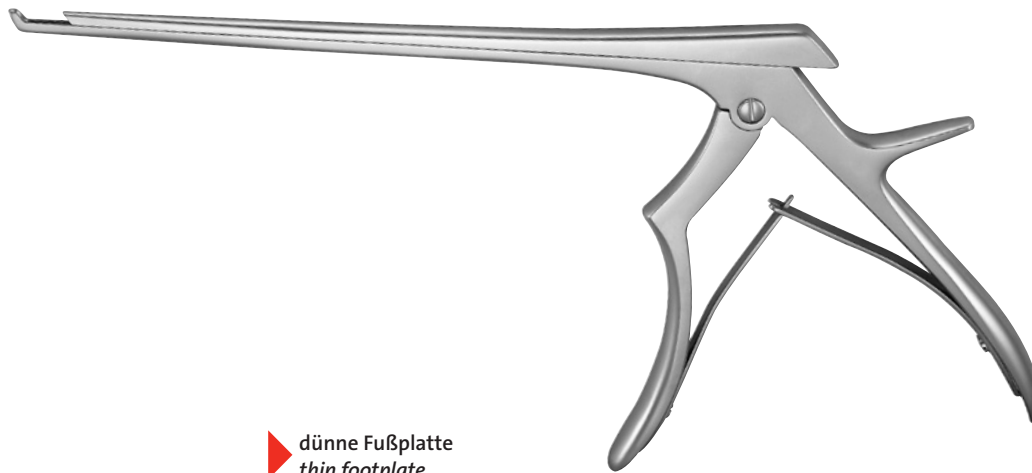

▶ dünne Fußplatte
thin footplate



FERRIS-SMITH-KERRISON

1 mm 2 mm 3 mm 4 mm 5 mm 6 mm

aufwärts schneidend up bite	Schaftlänge length of shaft	Bestell-Nr. Ordering No.	Bestell-Nr. Ordering No.	Bestell-Nr. Ordering No.	Bestell-Nr. Ordering No.	Bestell-Nr. Ordering No.	Bestell-Nr. Ordering No.
	15 cm / 6 inch	45-035.01D	45-035.02D	45-035.03D	45-035.04D	45-035.05D	45-035.06D
	18 cm / 7 inch	45-040.01D	45-040.02D	45-040.03D	45-040.04D	45-040.05D	45-040.06D
	20 cm / 8 inch	45-045.01D	45-045.02D	45-045.03D	45-045.04D	45-045.05D	45-045.06D
	30 cm / 12 inch	45-046.01D	45-046.02D	45-046.03D	45-046.04D	45-046.05D	45-046.06D

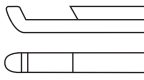
40° vorwärts schneidend 40° cutting forward	Schaftlänge length of shaft	Bestell-Nr. Ordering No.	Bestell-Nr. Ordering No.	Bestell-Nr. Ordering No.	Bestell-Nr. Ordering No.	Bestell-Nr. Ordering No.	Bestell-Nr. Ordering No.
	15 cm / 6 inch	45-050.01D	45-050.02D	45-050.03D	45-050.04D	45-050.05D	45-050.06D
	18 cm / 7 inch	45-055.01D	45-055.02D	45-055.03D	45-055.04D	45-055.05D	45-055.06D
	20 cm / 8 inch	45-060.01D	45-060.02D	45-060.03D	45-060.04D	45-060.05D	45-060.06D
	30 cm / 12 inch	45-061.01D	45-061.02D	45-061.03D	45-061.04D	45-061.05D	45-061.06D

abwärts schneidend down bite	Schaftlänge length of shaft	Bestell-Nr. Ordering No.	Bestell-Nr. Ordering No.	Bestell-Nr. Ordering No.	Bestell-Nr. Ordering No.	Bestell-Nr. Ordering No.	Bestell-Nr. Ordering No.
	15 cm / 6 inch	45-065.01D	45-065.02D	45-065.03D	45-065.04D	45-065.05D	45-065.06D
	18 cm / 7 inch	45-070.01D	45-070.02D	45-070.03D	45-070.04D	45-070.05D	45-070.06D
	20 cm / 8 inch	45-075.01D	45-075.02D	45-075.03D	45-075.04D	45-075.05D	45-075.06D
	30 cm / 12 inch	45-076.01D	45-076.02D	45-076.03D	45-076.04D	45-076.05D	45-076.06D

▶ andere Schaftlängen auf Anfrage
other shaft sizes upon request





▶ **Farbkodierter Silikongriff**
Color coded silicone handle



FERRIS-SMITH-KERRISON

1 mm 2 mm 3 mm 4 mm 5 mm 6 mm

aufwärts schneidend <i>up bite</i>	Schaftlänge <i>length of shaft</i>	Bestell-Nr. <i>Ordering No.</i>	Bestell-Nr. <i>Ordering No.</i>	Bestell-Nr. <i>Ordering No.</i>	Bestell-Nr. <i>Ordering No.</i>	Bestell-Nr. <i>Ordering No.</i>	Bestell-Nr. <i>Ordering No.</i>
	15 cm / 6 inch	45-035.01S	45-035.02S	45-035.03S	45-035.04S	45-035.05S	45-035.06S
	18 cm / 7 inch	45-040.01S	45-040.02S	45-040.03S	45-040.04S	45-040.05S	45-040.06S
	20 cm / 8 inch	45-045.01S	45-045.02S	45-045.03S	45-045.04S	45-045.05S	45-045.06S
	30 cm / 12 inch	45-046.01S	45-046.02S	45-046.03S	45-046.04S	45-046.05S	45-046.06S

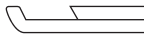
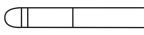
40° vorwärts schneidend <i>40° cutting forward</i>	Schaftlänge <i>length of shaft</i>	Bestell-Nr. <i>Ordering No.</i>	Bestell-Nr. <i>Ordering No.</i>	Bestell-Nr. <i>Ordering No.</i>	Bestell-Nr. <i>Ordering No.</i>	Bestell-Nr. <i>Ordering No.</i>	Bestell-Nr. <i>Ordering No.</i>
	15 cm / 6 inch	45-050.01S	45-050.02S	45-050.03S	45-050.04S	45-050.05S	45-050.06S
	18 cm / 7 inch	45-055.01S	45-055.02S	45-055.03S	45-055.04S	45-055.05S	45-055.06S
	20 cm / 8 inch	45-060.01S	45-060.02S	45-060.03S	45-060.04S	45-060.05S	45-060.06S
	30 cm / 12 inch	45-061.01S	45-061.02S	45-061.03S	45-061.04S	45-061.05S	45-061.06S

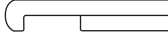
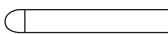
abwärts schneidend <i>down bite</i>	Schaftlänge <i>length of shaft</i>	Bestell-Nr. <i>Ordering No.</i>	Bestell-Nr. <i>Ordering No.</i>	Bestell-Nr. <i>Ordering No.</i>	Bestell-Nr. <i>Ordering No.</i>	Bestell-Nr. <i>Ordering No.</i>	Bestell-Nr. <i>Ordering No.</i>
	15 cm / 6 inch	45-065.01S	45-065.02S	45-065.03S	45-065.04S	45-065.05S	45-065.06S
	18 cm / 7 inch	45-070.01S	45-070.02S	45-070.03S	45-070.04S	45-070.05S	45-070.06S
	20 cm / 8 inch	45-075.01S	45-075.02S	45-075.03S	45-075.04S	45-075.05S	45-075.06S
	30 cm / 12 inch	45-076.01S	45-076.02S	45-076.03S	45-076.04S	45-076.05S	45-076.06S

▶ **andere Schaftlängen auf Anfrage**
other shaft sizes upon request





▶ Bayonett-Schaft, „CERAMIC“-Beschichtung
Bayonet shaft, „CERAMIC“ coating



FERRIS-SMITH-KERRISON

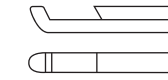



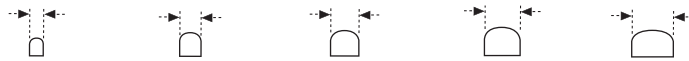
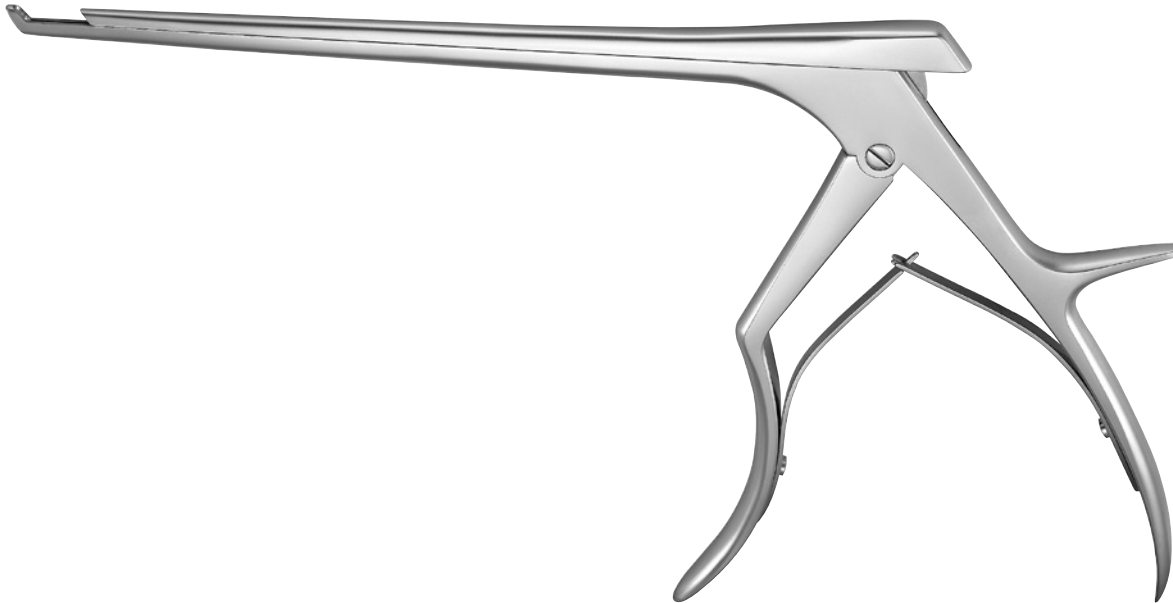

1 mm 2 mm 3 mm 4 mm 5 mm 6 mm

	Schaftlänge length of shaft	Bestell-Nr. Ordering No.	Bestell-Nr. Ordering No.	Bestell-Nr. Ordering No.	Bestell-Nr. Ordering No.	Bestell-Nr. Ordering No.	Bestell-Nr. Ordering No.
aufwärts schneidend up bite 	15 cm / 6 inch	45-035.01BAYBL	45-035.02BAYBL	45-035.03BAYBL	45-035.04BAYBL	45-035.05BAYBL	45-035.06BAYBL
	18 cm / 7 inch	45-040.01BAYBL	45-040.02BAYBL	45-040.03BAYBL	45-040.04BAYBL	45-040.05BAYBL	45-040.06BAYBL
	20 cm / 8 inch	45-045.01BAYBL	45-045.02BAYBL	45-045.03BAYBL	45-045.04BAYBL	45-045.05BAYBL	45-045.06BAYBL
	30 cm / 12 inch	45-046.01BAYBL	45-046.02BAYBL	45-046.03BAYBL	45-046.04BAYBL	45-046.05BAYBL	45-046.06BAYBL
40° vorwärts schneidend 40° cutting forward 	15 cm / 6 inch	45-050.01BAYBL	45-050.02BAYBL	45-050.03BAYBL	45-050.04BAYBL	45-050.05BAYBL	45-050.06BAYBL
	18 cm / 7 inch	45-055.01BAYBL	45-055.02BAYBL	45-055.03BAYBL	45-055.04BAYBL	45-055.05BAYBL	45-055.06BAYBL
	20 cm / 8 inch	45-060.01BAYBL	45-060.02BAYBL	45-060.03BAYBL	45-060.04BAYBL	45-060.05BAYBL	45-060.06BAYBL
	30 cm / 12 inch	45-061.01BAYBL	45-061.02BAYBL	45-061.03BAYBL	45-061.04BAYBL	45-061.05BAYBL	45-061.06BAYBL
abwärts schneidend down bite 	15 cm / 6 inch	45-065.01BAYBL	45-065.02BAYBL	45-065.03BAYBL	45-065.04BAYBL	45-065.05BAYBL	45-065.06BAYBL
	18 cm / 7 inch	45-070.01BAYBL	45-070.02BAYBL	45-070.03BAYBL	45-070.04BAYBL	45-070.05BAYBL	45-070.06BAYBL
	20 cm / 8 inch	45-075.01BAYBL	45-075.02BAYBL	45-075.03BAYBL	45-075.04BAYBL	45-075.05BAYBL	45-075.06BAYBL
	30 cm / 12 inch	45-076.01BAYBL	45-076.02BAYBL	45-076.03BAYBL	45-076.04BAYBL	45-076.05BAYBL	45-076.06BAYBL

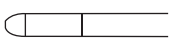
▶ andere Schaftlängen auf Anfrage
other shaft sizes upon request

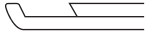
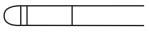

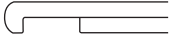
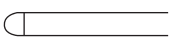
LOVE-KERRISON

		2 mm	3 mm	4 mm	5 mm	6 mm	
aufwärts schneidend <i>up bite</i>	Schaftlänge <i>length of shaft</i>	Bestell-Nr. <i>Ordering No.</i>	Bestell-Nr. <i>Ordering No.</i>	Bestell-Nr. <i>Ordering No.</i>	Bestell-Nr. <i>Ordering No.</i>	Bestell-Nr. <i>Ordering No.</i>	
		15 cm / 6 inch	45-110.02	45-110.03	45-110.04	45-110.05	45-110.06
		18 cm / 7 inch	45-115.02	45-115.03	45-115.04	45-115.05	45-115.06
		20 cm / 8 inch	45-120.02	45-120.03	45-120.04	45-120.05	45-120.06
		30 cm / 12 inch	45-121.02	45-121.03	45-121.04	45-121.05	45-121.06
40° vorwärts schneidend <i>40° cutting forward</i>	Schaftlänge <i>length of shaft</i>	Bestell-Nr. <i>Ordering No.</i>	Bestell-Nr. <i>Ordering No.</i>	Bestell-Nr. <i>Ordering No.</i>	Bestell-Nr. <i>Ordering No.</i>	Bestell-Nr. <i>Ordering No.</i>	
		15 cm / 6 inch	45-125.02	45-125.03	45-125.04	45-125.05	45-125.06
		18 cm / 7 inch	45-130.02	45-130.03	45-130.04	45-130.05	45-130.06
		20 cm / 8 inch	45-135.02	45-135.03	45-135.04	45-135.05	45-135.06
		30 cm / 12 inch	45-136.02	45-136.03	45-136.04	45-136.05	45-136.06
abwärts schneidend <i>down bite</i>	Schaftlänge <i>length of shaft</i>	Bestell-Nr. <i>Ordering No.</i>	Bestell-Nr. <i>Ordering No.</i>	Bestell-Nr. <i>Ordering No.</i>	Bestell-Nr. <i>Ordering No.</i>	Bestell-Nr. <i>Ordering No.</i>	
		15 cm / 6 inch	45-140.02	45-140.03	45-140.04	45-140.05	45-140.06
		18 cm / 7 inch	45-145.02	45-145.03	45-145.04	45-145.05	45-145.06
		20 cm / 8 inch	45-150.02	45-150.03	45-150.04	45-150.05	45-150.06
		30 cm / 12 inch	45-151.02	45-151.03	45-151.04	45-151.05	45-151.06

▶ andere Schaftlängen auf Anfrage
other shaft sizes upon request

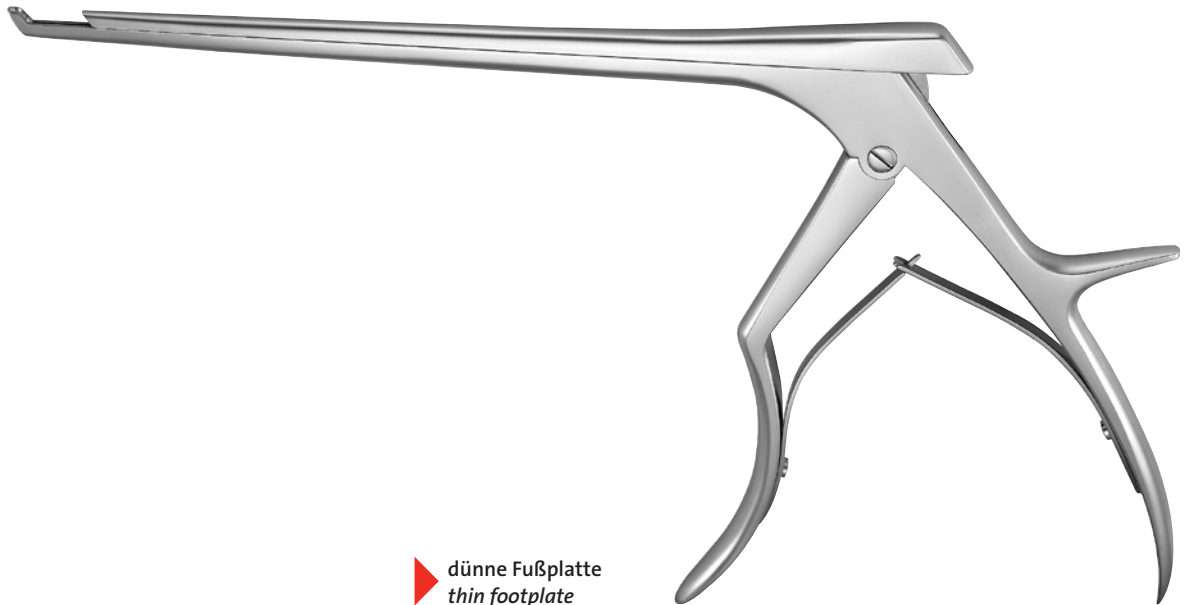

▶ dünne Fußplatte
thin footplate

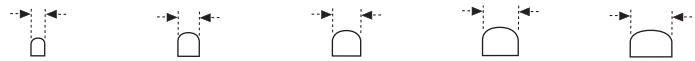

LOVE-KERRISON

2 mm 3 mm 4 mm 5 mm 6 mm

aufwärts schneidend up bite	Schaftlänge length of shaft	Bestell-Nr. Ordering No.	Bestell-Nr. Ordering No.	Bestell-Nr. Ordering No.	Bestell-Nr. Ordering No.	Bestell-Nr. Ordering No.
	15 cm / 6 inch	45-110.02D	45-110.03D	45-110.04D	45-110.05D	45-110.06D
	18 cm / 7 inch	45-115.02D	45-115.03D	45-115.04D	45-115.05D	45-115.06D
	20 cm / 8 inch	45-120.02D	45-120.03D	45-120.04D	45-120.05D	45-120.06D
	30 cm / 12 inch	45-121.02D	45-121.03D	45-121.04D	45-121.05D	45-121.06D

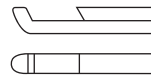
40° vorwärts schneidend 40° cutting forward	Schaftlänge length of shaft	Bestell-Nr. Ordering No.	Bestell-Nr. Ordering No.	Bestell-Nr. Ordering No.	Bestell-Nr. Ordering No.	Bestell-Nr. Ordering No.
	15 cm / 6 inch	45-125.02D	45-125.03D	45-125.04D	45-125.05D	45-125.06D
	18 cm / 7 inch	45-130.02D	45-130.03D	45-130.04D	45-130.05D	45-130.06D
	20 cm / 8 inch	45-135.02D	45-135.03D	45-135.04D	45-135.05D	45-135.06D
	30 cm / 12 inch	45-136.02D	45-136.03D	45-136.04D	45-136.05D	45-136.06D

abwärts schneidend down bite	Schaftlänge length of shaft	Bestell-Nr. Ordering No.	Bestell-Nr. Ordering No.	Bestell-Nr. Ordering No.	Bestell-Nr. Ordering No.	Bestell-Nr. Ordering No.
	15 cm / 6 inch	45-140.02D	45-140.03D	45-140.04D	45-140.05D	45-140.06D
	18 cm / 7 inch	45-145.02D	45-145.03D	45-145.04D	45-145.05D	45-145.06D
	20 cm / 8 inch	45-150.02D	45-150.03D	45-150.04D	45-150.05D	45-150.06D
	30 cm / 12 inch	45-151.02D	45-151.03D	45-151.04D	45-151.05D	45-151.06D

▶ andere Schaftlängen auf Anfrage
other shaft sizes upon request

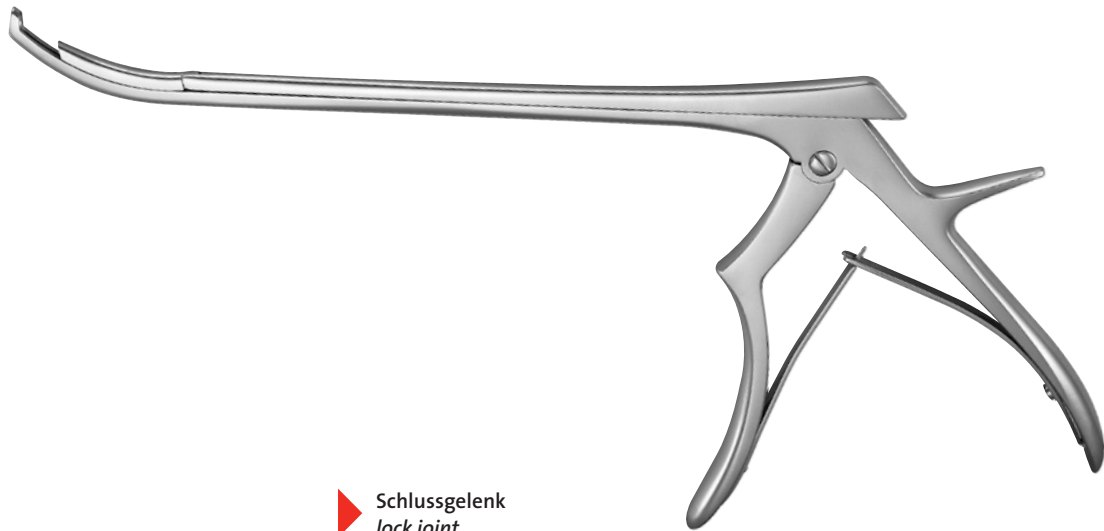

▶ Schlussgelenk
lock joint

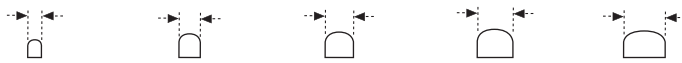

FERRIS-SMITH-KERRISON

2 mm 3 mm 4 mm 5 mm 6 mm

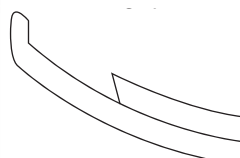
aufwärts schneidend up bite	Schaftlänge length of shaft	Bestell-Nr. Ordering No.	Bestell-Nr. Ordering No.	Bestell-Nr. Ordering No.	Bestell-Nr. Ordering No.	Bestell-Nr. Ordering No.
	18 cm / 7 inch	45-500.02	45-500.03	45-500.04	45-500.05	45-500.06
	20 cm / 8 inch	45-510.02	45-510.03	45-510.04	45-510.05	45-510.06
	25 cm / 10 inch	45-515.02	45-515.03	45-515.04	45-515.05	45-515.06
	30 cm / 12 inch	45-520.02	45-520.03	45-520.04	45-520.05	45-520.06

▶ andere Schaftlängen auf Anfrage
other shaft sizes upon request

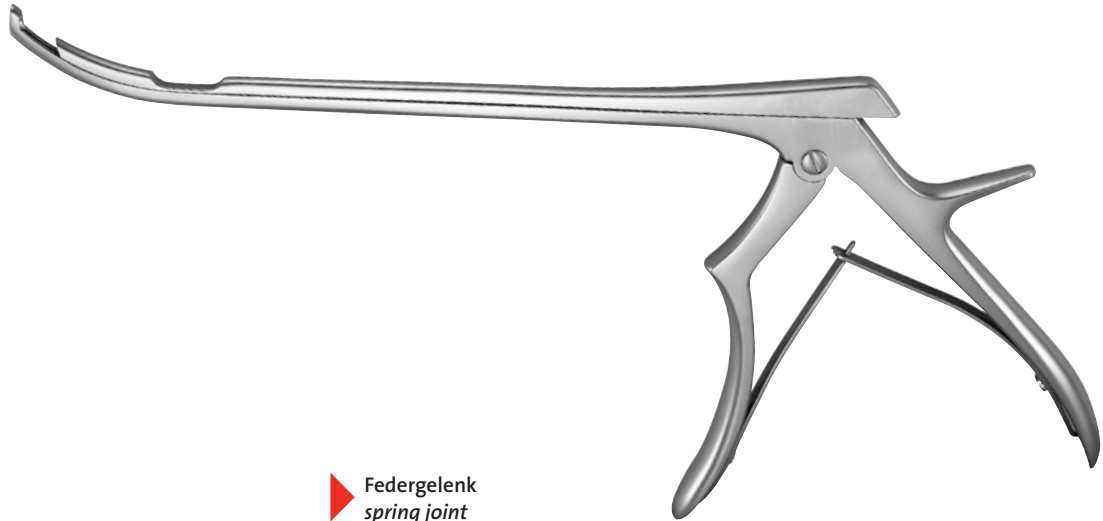

Federgelenk
spring joint

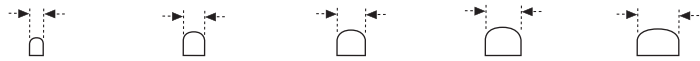

FERRIS-SMITH-KERRISON

2 mm 3 mm 4 mm 5 mm 6 mm

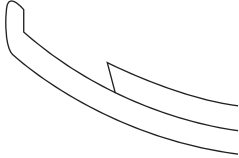
aufwärts schneidend up bite	Schaftlänge length of shaft	Bestell-Nr. Ordering No.	Bestell-Nr. Ordering No.	Bestell-Nr. Ordering No.	Bestell-Nr. Ordering No.	Bestell-Nr. Ordering No.
	18 cm / 7 inch	45-500.12	45-500.13	45-500.14	45-500.15	45-500.16
	20 cm / 8 inch	45-510.12	45-510.13	45-510.14	45-510.15	45-510.16
	25 cm / 10 inch	45-515.12	45-515.13	45-515.14	45-515.15	45-515.16
	30 cm / 12 inch	45-520.12	45-520.13	45-520.14	45-520.15	45-520.16

andere Schaftlängen auf Anfrage
other shaft sizes upon request



▶ Schlussgelenk
lock joint



FORAMENOTOMY RONGEURS

3 mm

4 mm

70° links abgebogen 70° left curved	Schaftlänge length of shaft	Bestell-Nr. Ordering No.	Bestell-Nr. Ordering No.
	20cm / 8 inch	45-509.53	45-509.54

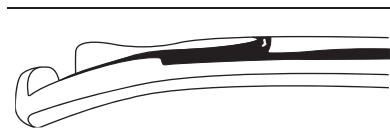

FORAMENOTOMY RONGEURS

3 mm





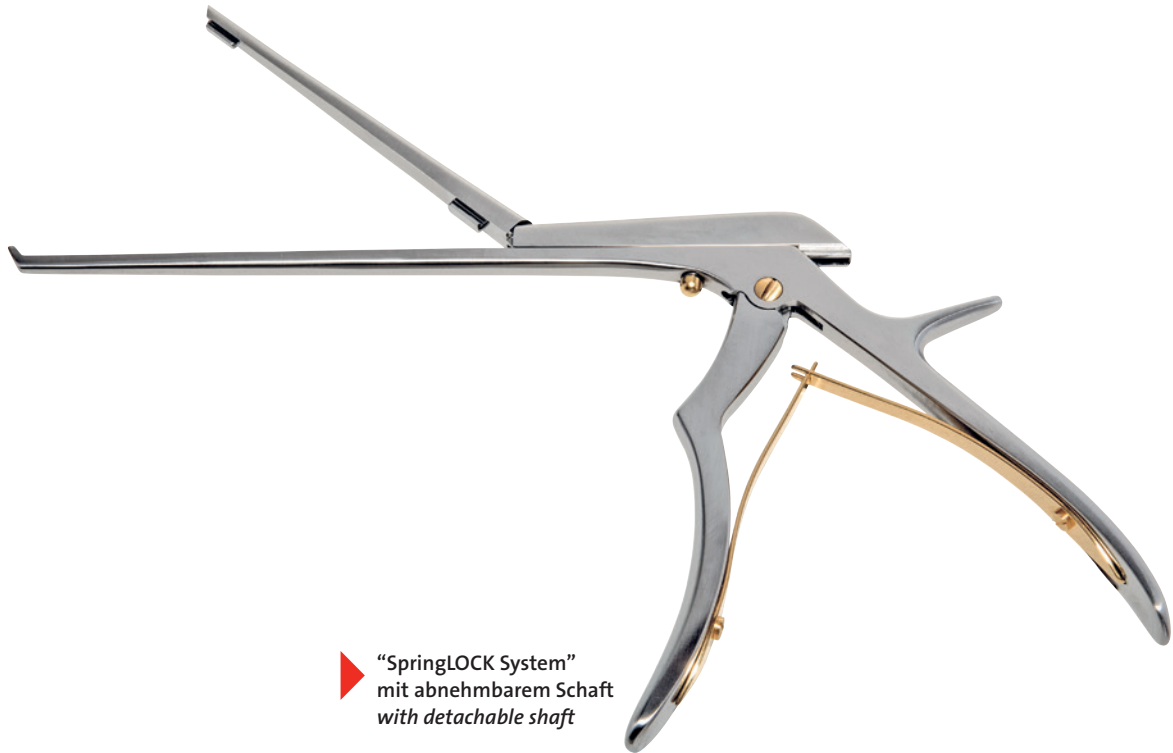

4 mm

70° rechts abgebogen 70° right curved	Schaftlänge length of shaft	Bestell-Nr. Ordering No.	Bestell-Nr. Ordering No.
	20cm / 8 inch	45-510.53	45-510.54

▶ andere Schaftlängen auf Anfrage
other shaft sizes upon request



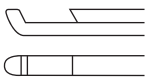

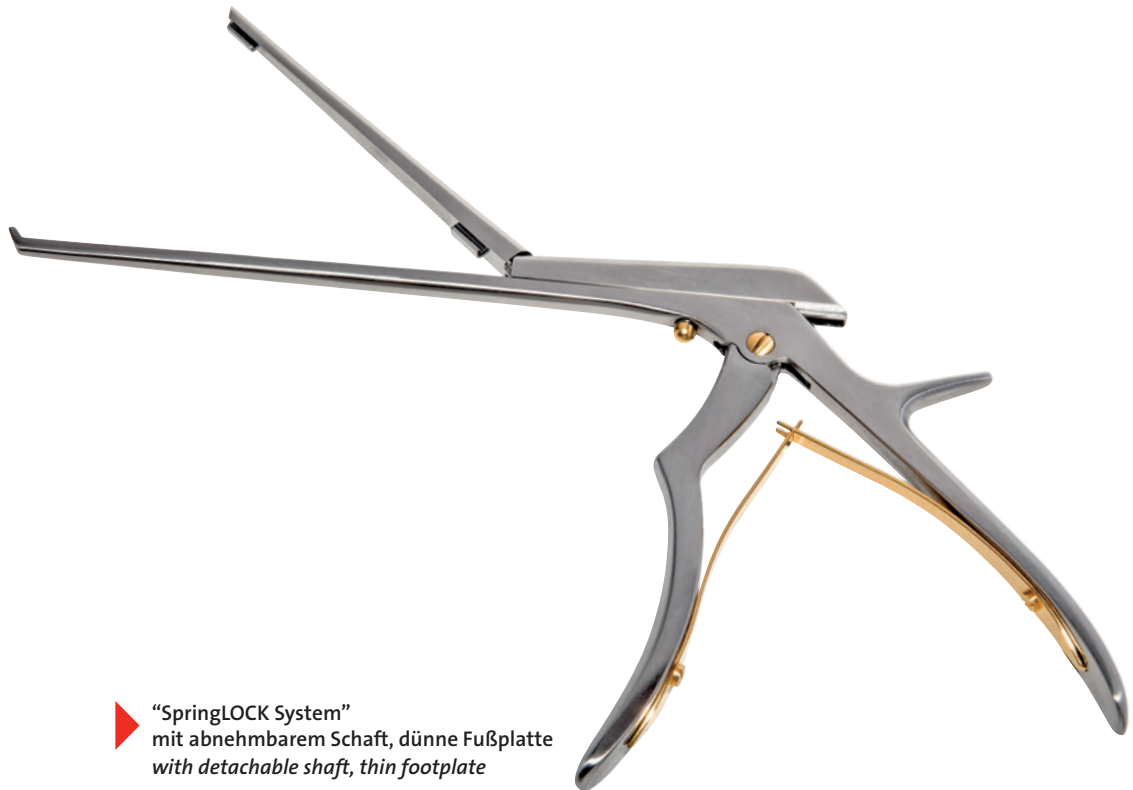

► “SpringLOCK System”
mit abnehmbarem Schaft
with detachable shaft

						
FERRIS-SMITH-KERRISON		2 mm	3 mm	4 mm	5 mm	6 mm
40° vorwärts schneidend 40° cutting forward	Schaftlänge length of shaft	Bestell-Nr. Ordering No.	Bestell-Nr. Ordering No.	Bestell-Nr. Ordering No.	Bestell-Nr. Ordering No.	Bestell-Nr. Ordering No.
	18 cm / 7 inch	45-918.02	45-918.03	45-918.04	45-918.05	45-918.06
	20 cm / 8 inch	45-920.02	45-920.03	45-920.04	45-920.05	45-920.06
	25 cm / 10 inch	45-925.02	45-925.03	45-925.04	45-925.05	45-925.06
	30 cm / 12 inch	45-930.02	45-930.03	45-930.04	45-930.05	45-930.06
aufwärts schneidend up bite	Schaftlänge length of shaft	Bestell-Nr. Ordering No.	Bestell-Nr. Ordering No.	Bestell-Nr. Ordering No.	Bestell-Nr. Ordering No.	Bestell-Nr. Ordering No.
	18 cm / 7 inch	45-919.02	45-919.03	45-919.04	45-919.05	45-919.06
	20 cm / 8 inch	45-921.02	45-921.03	45-921.04	45-921.05	45-921.06
	25 cm / 10 inch	45-926.02	45-926.03	45-926.04	45-926.05	45-926.06
	30 cm / 12 inch	45-931.02	45-931.03	45-931.04	45-931.05	45-931.06

► andere Schaftlängen auf Anfrage
other shaft sizes upon request

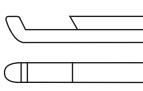
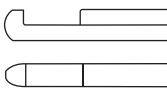

▶ “SpringLOCK System”
mit abnehmbarem Schaft, dünne Fußplatte
with detachable shaft, thin footplate

						
FERRIS-SMITH-KERRISON		2 mm	3 mm	4 mm	5 mm	6 mm
40° vorwärts schneidend 40° cutting forward	Schaftlänge length of shaft	Bestell-Nr. Ordering No.	Bestell-Nr. Ordering No.	Bestell-Nr. Ordering No.	Bestell-Nr. Ordering No.	Bestell-Nr. Ordering No.
	18 cm / 7 inch	45-918.02 D	45-918.03 D	45-918.04 D	45-918.05 D	45-918.06 D
	20 cm / 8 inch	45-920.02 D	45-920.03 D	45-920.04 D	45-920.05 D	45-920.06 D
	25 cm / 10 inch	45-925.02 D	45-925.03 D	45-925.04 D	45-925.05 D	45-925.06 D
	30 cm / 12 inch	45-930.02 D	45-930.03 D	45-930.04 D	45-930.05 D	45-930.06 D
aufwärts schneidend up bite	Schaftlänge length of shaft	Bestell-Nr. Ordering No.	Bestell-Nr. Ordering No.	Bestell-Nr. Ordering No.	Bestell-Nr. Ordering No.	Bestell-Nr. Ordering No.
	18 cm / 7 inch	45-919.02 D	45-919.03 D	45-919.04 D	45-919.05 D	45-919.06 D
	20 cm / 8 inch	45-921.02 D	45-921.03 D	45-921.04 D	45-921.05 D	45-921.06 D
	25 cm / 10 inch	45-926.02 D	45-926.03 D	45-926.04 D	45-926.05 D	45-926.06 D
	30 cm / 12 inch	45-931.02 D	45-931.03 D	45-931.04 D	45-931.05 D	45-931.06 D

▶ andere Schaftlängen auf Anfrage
other shaft sizes upon request

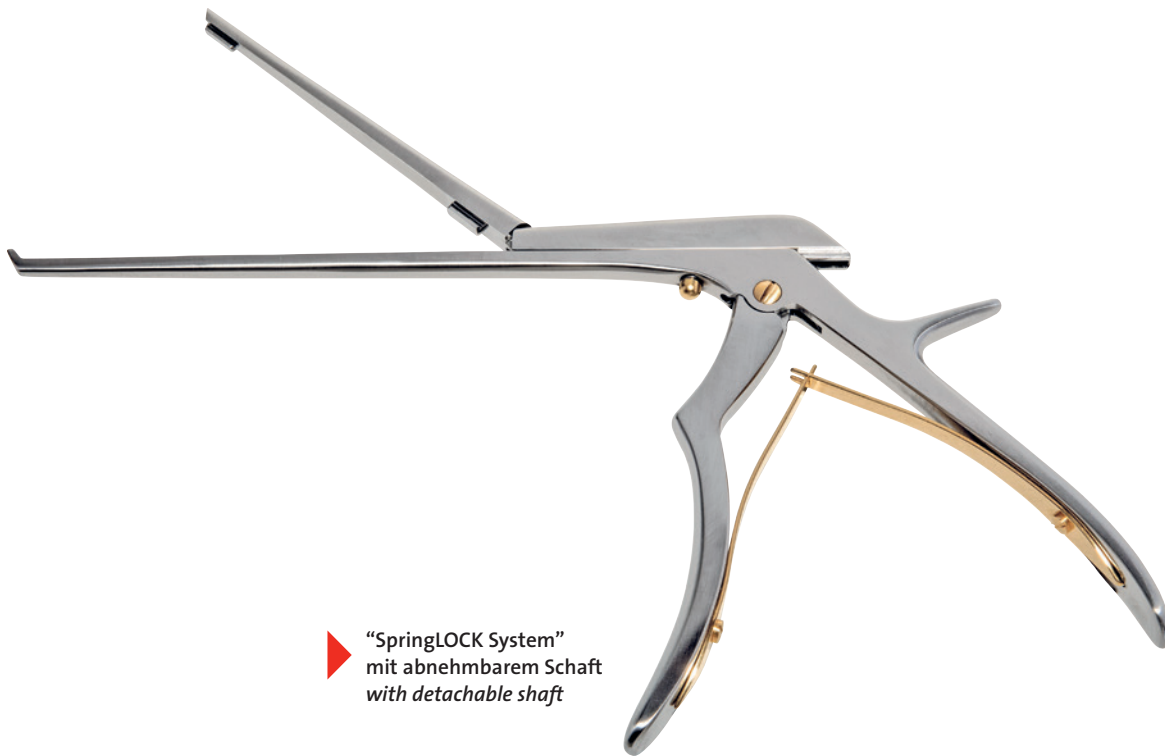

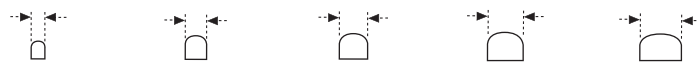

▶ “SpringLOCK System”
mit abnehmbarem Schaft
with detachable shaft

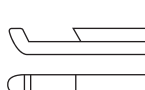

LOVE-KERRISON

2 mm 3 mm 4 mm 5 mm 6 mm

40° vorwärts schneidend 40° cutting forward	Schaftlänge length of shaft	Bestell-Nr. Ordering No.	Bestell-Nr. Ordering No.	Bestell-Nr. Ordering No.	Bestell-Nr. Ordering No.	Bestell-Nr. Ordering No.
	18 cm / 7 inch	45-418.02	45-418.03	45-418.04	45-418.05	45-418.06
	20 cm / 8 inch	45-420.02	45-420.03	45-420.04	45-420.05	45-420.06
	25 cm / 10 inch	45-425.02	45-425.03	45-425.04	45-425.05	45-425.06
	30 cm / 12 inch	45-430.02	45-430.03	45-430.04	45-430.05	45-430.06

aufwärts schneidend up bite	Schaftlänge length of shaft	Bestell-Nr. Ordering No.	Bestell-Nr. Ordering No.	Bestell-Nr. Ordering No.	Bestell-Nr. Ordering No.	Bestell-Nr. Ordering No.
	18 cm / 7 inch	45-419.02	45-419.03	45-419.04	45-419.05	45-419.06
	20 cm / 8 inch	45-421.02	45-421.03	45-421.04	45-421.05	45-421.06
	25 cm / 10 inch	45-426.02	45-426.03	45-426.04	45-426.05	45-426.06
	30 cm / 12 inch	45-431.02	45-431.03	45-431.04	45-431.05	45-431.06

▶ andere Schaftlängen auf Anfrage
other shaft sizes upon request

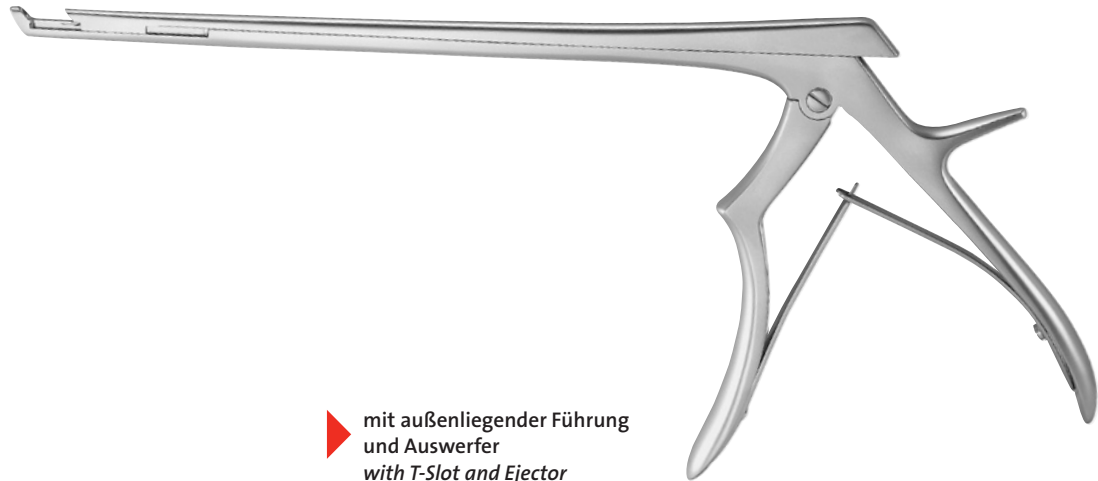

mit außenliegender Führung
und Auswerfer
with T-Slot and Ejector

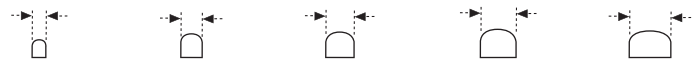

FERRIS-SMITH-KERRISON

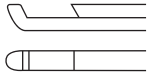
		2 mm	3 mm	4 mm	5 mm	6 mm
aufwärts schneidend up bite 	Schaftlänge length of shaft	Bestell-Nr. Ordering No.	Bestell-Nr. Ordering No.	Bestell-Nr. Ordering No.	Bestell-Nr. Ordering No.	Bestell-Nr. Ordering No.
	15 cm / 6 inch	45-035.102	45-035.103	45-035.104	45-035.105	45-035.106
	18 cm / 7 inch	45-040.102	45-040.103	45-040.104	45-040.105	45-040.106
	20 cm / 8 inch	45-045.102	45-045.103	45-045.104	45-045.105	45-045.106
	30 cm / 12 inch	45-046.102	45-046.103	45-046.104	45-046.105	45-046.106
40° vorwärts schneidend 40° cutting forward 	Schaftlänge length of shaft	Bestell-Nr. Ordering No.	Bestell-Nr. Ordering No.	Bestell-Nr. Ordering No.	Bestell-Nr. Ordering No.	Bestell-Nr. Ordering No.
	15 cm / 6 inch	45-050.102	45-050.103	45-050.104	45-050.105	45-050.106
	18 cm / 7 inch	45-055.102	45-055.103	45-055.104	45-055.105	45-055.106
	20 cm / 8 inch	45-060.102	45-060.103	45-060.104	45-060.105	45-060.106
	30 cm / 12 inch	45-061.102	45-061.103	45-061.104	45-061.105	45-061.106

andere Schaftlängen auf Anfrage
other shaft sizes upon request

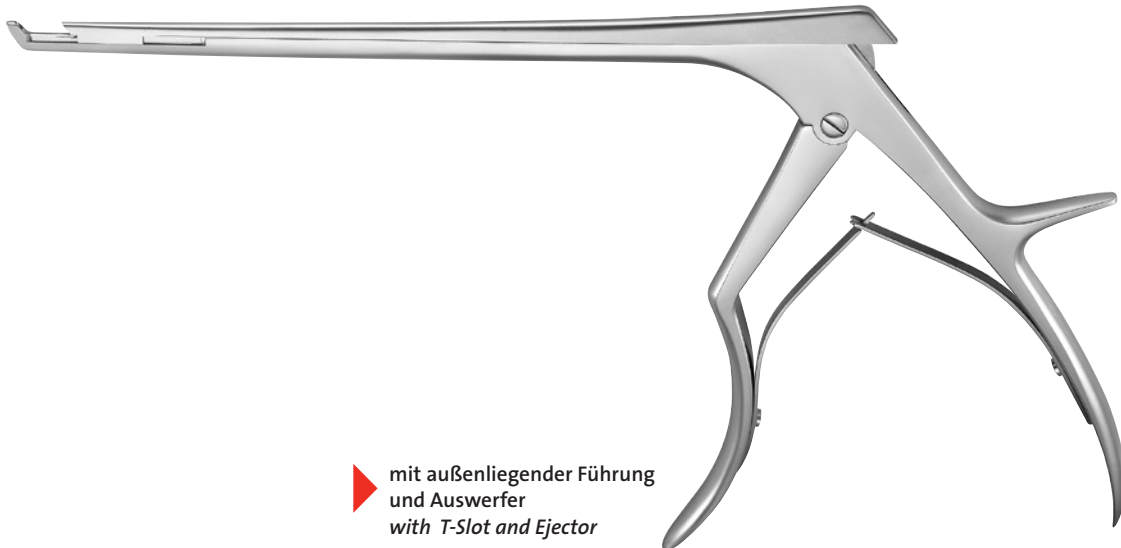

mit außenliegender Führung
und Auswerfer
with T-Slot and Ejector

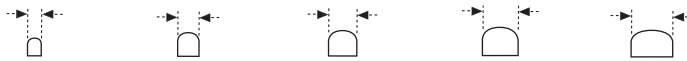

LOVE-KERRISON

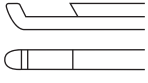
		2 mm	3 mm	4 mm	5 mm	6 mm
aufwärts schneidend <i>up bite</i>	Schaftlänge <i>length of shaft</i>	Bestell-Nr. <i>Ordering No.</i>	Bestell-Nr. <i>Ordering No.</i>	Bestell-Nr. <i>Ordering No.</i>	Bestell-Nr. <i>Ordering No.</i>	Bestell-Nr. <i>Ordering No.</i>
	15 cm / 6 inch	45-110.102	45-110.103	45-110.104	45-110.105	45-110.106
	18 cm / 7 inch	45-115.102	45-115.103	45-115.104	45-115.105	45-115.106
	20 cm / 8 inch	45-120.102	45-120.103	45-120.104	45-120.105	45-120.106
	30 cm / 12 inch	45-121.102	45-121.103	45-121.104	45-121.105	45-121.106
40° vorwärts schneidend <i>40° cutting forward</i>	Schaftlänge <i>length of shaft</i>	Bestell-Nr. <i>Ordering No.</i>	Bestell-Nr. <i>Ordering No.</i>	Bestell-Nr. <i>Ordering No.</i>	Bestell-Nr. <i>Ordering No.</i>	Bestell-Nr. <i>Ordering No.</i>
	15 cm / 6 inch	45-125.102	45-125.103	45-125.104	45-125.105	45-125.106
	18 cm / 7 inch	45-130.102	45-130.103	45-130.104	45-130.105	45-130.106
	20 cm / 8 inch	45-135.102	45-135.103	45-135.104	45-135.105	45-135.106
	30 cm / 12 inch	45-136.102	45-136.103	45-136.104	45-136.105	45-136.106

andere Schaftlängen auf Anfrage
other shaft sizes upon request

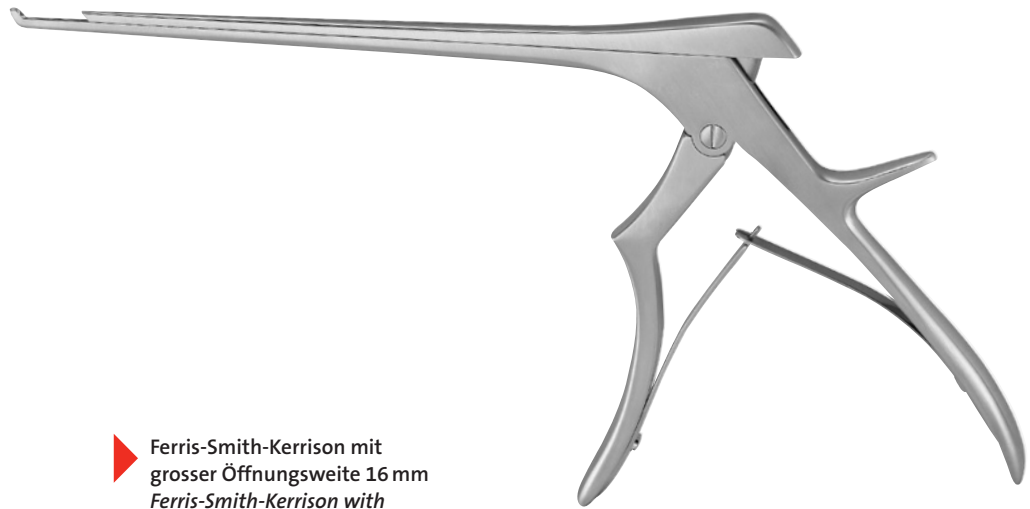

▶ Ferris-Smith-Kerrison mit grosser Öffnungsweite 16 mm
Ferris-Smith-Kerrison with wide opening 16 mm



FERRIS-SMITH-KERRISON

1 mm 2 mm 3 mm 4 mm 5 mm 6 mm

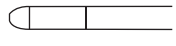
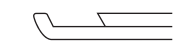
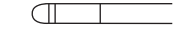
	Schaftlänge <i>length of shaft</i>	Bestell-Nr. <i>Ordering No.</i>	Bestell-Nr. <i>Ordering No.</i>	Bestell-Nr. <i>Ordering No.</i>	Bestell-Nr. <i>Ordering No.</i>	Bestell-Nr. <i>Ordering No.</i>	Bestell-Nr. <i>Ordering No.</i>
aufwärts schneidend <i>up bite</i>							
	15 cm / 6 inch	45-113.01	45-113.02	45-113.03	45-113.04	45-113.05	45-113.06
	18 cm / 7 inch	45-118.01	45-118.02	45-118.03	45-118.04	45-118.05	45-118.06
	20 cm / 8 inch	45-158.01	45-158.02	45-158.03	45-158.04	45-158.05	45-158.06
	30 cm / 12 inch	45-168.01	45-168.02	45-168.03	45-168.04	45-168.05	45-168.06
40° vorwärts schneidend <i>40° cutting forward</i>							
	15 cm / 6 inch	45-112.01	45-112.02	45-112.03	45-112.04	45-112.05	45-112.06
	18 cm / 7 inch	45-117.01	45-117.02	45-117.03	45-117.04	45-117.05	45-117.06
	20 cm / 8 inch	45-157.01	45-157.02	45-157.03	45-157.04	45-157.05	45-157.06
	30 cm / 12 inch	45-167.01	45-167.02	45-167.03	45-167.04	45-167.05	45-167.06

▶ andere Schaftlängen auf Anfrage
other shaft sizes upon request

CERAMIC *Instruments*

Individually made for **our customers**

Unsere Instrumente mit „CERAMIC“-Beschichtung zeichnen sich durch folgende Vorteile aus:

- Leichte Handhabung durch verringerte Oberflächen-Reibung an den mechanischen Kontaktstellen
- Kratzbeständig auch bei hohen mechanischen Belastungen
- Temperaturbeständig
- Nichtrostend und korrosionsfest gegen die meisten verdünnten Säuren und Laugen
- Minimale optische Reflexion für kontrastscharfe Bildgebung im Operationsfeld
- Einfache Reinigung durch optimierte Oberflächenstruktur

Our CERAMIC coated instruments offer the following advantages:

- *Smooth action due to less surface friction*
- *Scratch resistance*
- *Maximum durability*
- *Non reflective*
- *Higher corrosion resistance*
- *Aesthetical*
- *Validated biocompatibility*
- *Easy to clean due to improved surface structure*



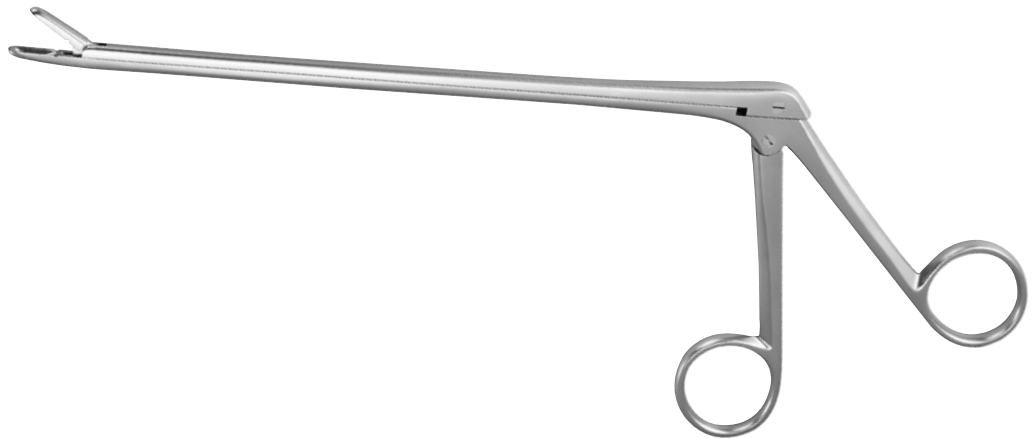



CUSHING

LOVE GRÜNWARD

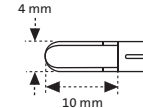
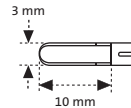
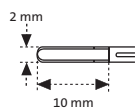
SPURLING



	gerade <i>straight</i>	Schaftlänge <i>length of shaft</i>	Bestell-Nr. <i>Ordering No.</i>	Bestell-Nr. <i>Ordering No.</i>	Bestell-Nr. <i>Ordering No.</i>
		13 cm / 5 1/4 inch	46-005.02	46-005.03	46-005.04
		14 cm / 5 1/2 inch	46-020.02	46-020.03	46-020.04
		15 cm / 6 inch	46-035.02	46-035.03	46-035.04
		18 cm / 7 inch	46-050.02	46-050.03	46-050.04

	auf <i>up</i>	Schaftlänge <i>length of shaft</i>	Bestell-Nr. <i>Ordering No.</i>	Bestell-Nr. <i>Ordering No.</i>	Bestell-Nr. <i>Ordering No.</i>
		13 cm / 5 1/4 inch	46-010.02	46-010.03	46-010.04
		14 cm / 5 1/2 inch	46-025.02	46-025.03	46-025.04
		15 cm / 6 inch	46-040.02	46-040.03	46-040.04
		18 cm / 7 inch	46-055.02	46-055.03	46-055.04

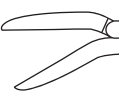
	ab <i>down</i>	Schaftlänge <i>length of shaft</i>	Bestell-Nr. <i>Ordering No.</i>	Bestell-Nr. <i>Ordering No.</i>	Bestell-Nr. <i>Ordering No.</i>
		13 cm / 5 1/4 inch	46-015.02	46-015.03	46-015.04
		14 cm / 5 1/2 inch	46-030.02	46-030.03	46-030.04
		15 cm / 6 inch	46-045.02	46-045.03	46-045.04
		18 cm / 7 inch	46-060.02	46-060.03	46-060.04

 unteres Maulteil beweglich
lower jaw movable

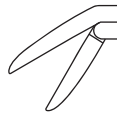
	ab <i>down</i>	Schaftlänge <i>length of shaft</i>	Bestell-Nr. <i>Ordering No.</i>	Bestell-Nr. <i>Ordering No.</i>	Bestell-Nr. <i>Ordering No.</i>
		13 cm / 5 1/4 inch	46-017.02	46-017.03	46-017.04
		14 cm / 5 1/2 inch	46-031.02	46-031.03	46-031.04
		15 cm / 6 inch	46-046.02	46-046.03	46-046.04
		18 cm / 7 inch	46-059.02	46-059.03	46-059.04

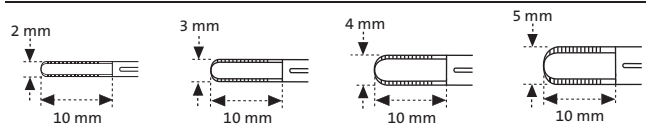

SCHLESINGER

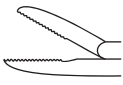
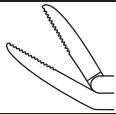
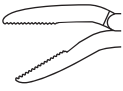
gerade straight	Schaftlänge length of shaft	Bestell-Nr. Ordering No.	Bestell-Nr. Ordering No.	Bestell-Nr. Ordering No.	Bestell-Nr. Ordering No.
	13 cm / 5 1/4 inch	46-100.02	46-100.03	46-100.04	46-100.05
	15 cm / 6 inch	46-115.02	46-115.03	46-115.04	46-115.05
	18 cm / 7 inch	46-116.02	46-116.03	46-116.04	46-116.05
auf up	Schaftlänge length of shaft	Bestell-Nr. Ordering No.	Bestell-Nr. Ordering No.	Bestell-Nr. Ordering No.	Bestell-Nr. Ordering No.
	13 cm / 5 1/4 inch	46-105.02	46-105.03	46-105.04	46-105.05
	15 cm / 6 inch	46-120.02	46-120.03	46-120.04	46-120.05
	18 cm / 7 inch	46-117.02	46-117.03	46-117.04	46-117.05
ab down	Schaftlänge length of shaft	Bestell-Nr. Ordering No.	Bestell-Nr. Ordering No.	Bestell-Nr. Ordering No.	Bestell-Nr. Ordering No.
	13 cm / 5 1/4 inch	46-110.02	46-110.03	46-110.04	46-110.05
	15 cm / 6 inch	46-125.02	46-125.03	46-125.04	46-125.05
	18 cm / 7 inch	46-118.02	46-118.03	46-118.04	46-118.05

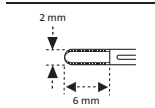



PEAPOD

	auf up	Schaftlänge length of shaft	Bestell-Nr. Ordering No.
		14 cm / 5½ inch	46-150.02

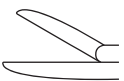
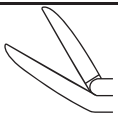

CASPAR RONGEUR



		2x12mm	3x12mm	4x14mm	5x14mm	6x16mm
gerade straight	Schaftlänge length of shaft	Bestell-Nr. Ordering No.	Bestell-Nr. Ordering No.	Bestell-Nr. Ordering No.	Bestell-Nr. Ordering No.	Bestell-Nr. Ordering No.
	14 cm / 5½ inch	46-036.20	46-036.30	46-036.40	46-036.50	46-036.60
	16 cm / 6¼ inch	46-036.02	46-036.03	46-036.04	46-036.05	46-036.06
	18 cm / 7 inch	46-036.22	46-036.33	46-036.44	46-036.55	46-036.66
auf up	Schaftlänge length of shaft	Bestell-Nr. Ordering No.	Bestell-Nr. Ordering No.	Bestell-Nr. Ordering No.	Bestell-Nr. Ordering No.	Bestell-Nr. Ordering No.
	14 cm / 5½ inch	46-037.20	46-037.30	46-037.40	46-037.50	46-037.60
	16 cm / 6¼ inch	46-037.02	46-037.03	46-037.04	46-037.05	46-037.06
	18 cm / 7 inch	46-037.22	46-037.33	46-037.44	46-037.55	46-037.66
ab down	Schaftlänge length of shaft	Bestell-Nr. Ordering No.	Bestell-Nr. Ordering No.	Bestell-Nr. Ordering No.	Bestell-Nr. Ordering No.	Bestell-Nr. Ordering No.
	14 cm / 5½ inch	46-038.20	46-038.30	46-038.40	46-038.50	46-038.60
	16 cm / 6¼ inch	46-038.02	46-038.03	46-038.04	46-038.05	46-038.06
	18 cm / 7 inch	46-038.22	46-038.33	46-038.44	46-038.55	46-038.66

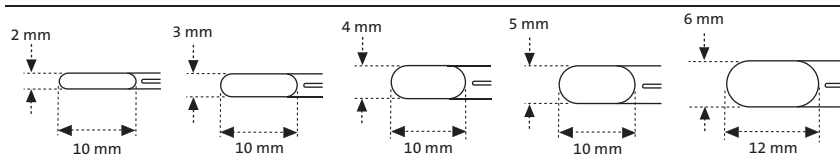

▶ **Modifizierter Ringgriff**
Modified ring handle

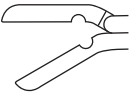
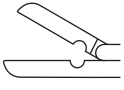

FERRIS-SMITH



	ab down	Schaftlänge length of shaft	Bestell-Nr. Ordering No.	Bestell-Nr. Ordering No.	Bestell-Nr. Ordering No.	Bestell-Nr. Ordering No.	Bestell-Nr. Ordering No.
		18 cm / 7 inch	47-005.02	47-005.03	47-005.04	47-005.05	47-005.06
		20 cm / 8 inch	47-010.02	47-010.03	47-010.04	47-010.05	47-010.06
	gerade straight	Schaftlänge length of shaft	Bestell-Nr. Ordering No.	Bestell-Nr. Ordering No.	Bestell-Nr. Ordering No.	Bestell-Nr. Ordering No.	Bestell-Nr. Ordering No.
		18 cm / 7 inch	47-015.02	47-015.03	47-015.04	47-015.05	47-015.06
		20 cm / 8 inch	47-020.02	47-020.03	47-020.04	47-020.05	47-020.06
	auf up	Schaftlänge length of shaft	Bestell-Nr. Ordering No.	Bestell-Nr. Ordering No.	Bestell-Nr. Ordering No.	Bestell-Nr. Ordering No.	Bestell-Nr. Ordering No.
		18 cm / 7 inch	47-025.02	47-025.03	47-025.04	47-025.05	47-025.06
		20 cm / 8 inch	47-030.02	47-030.03	47-030.04	47-030.05	47-030.06

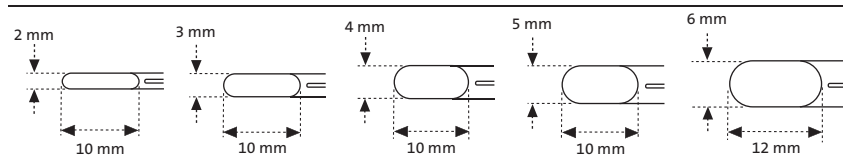

mit Kniegriff
Kerrison handle

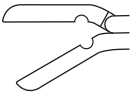
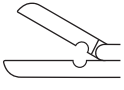

FERRIS-SMITH

	ab down	Schaftlänge length of shaft	Bestell-Nr. Ordering No.	Bestell-Nr. Ordering No.	Bestell-Nr. Ordering No.	Bestell-Nr. Ordering No.	Bestell-Nr. Ordering No.
		18 cm / 7 inch	47-006.02	47-006.03	47-006.04	47-006.05	47-006.06
		20 cm / 8 inch	47-011.02	47-011.03	47-011.04	47-011.05	47-011.06
	gerade straight	Schaftlänge length of shaft	Bestell-Nr. Ordering No.	Bestell-Nr. Ordering No.	Bestell-Nr. Ordering No.	Bestell-Nr. Ordering No.	Bestell-Nr. Ordering No.
		18 cm / 7 inch	47-019.02	47-019.03	47-019.04	47-019.05	47-019.06
		20 cm / 8 inch	47-021.02	47-021.03	47-021.04	47-021.05	47-021.06
	auf up	Schaftlänge length of shaft	Bestell-Nr. Ordering No.	Bestell-Nr. Ordering No.	Bestell-Nr. Ordering No.	Bestell-Nr. Ordering No.	Bestell-Nr. Ordering No.
		18 cm / 7 inch	47-026.02	47-026.03	47-026.04	47-026.05	47-026.06
		20 cm / 8 inch	47-031.02	47-031.03	47-031.04	47-031.05	47-031.06

FERRIS-SMITH-KERRISON

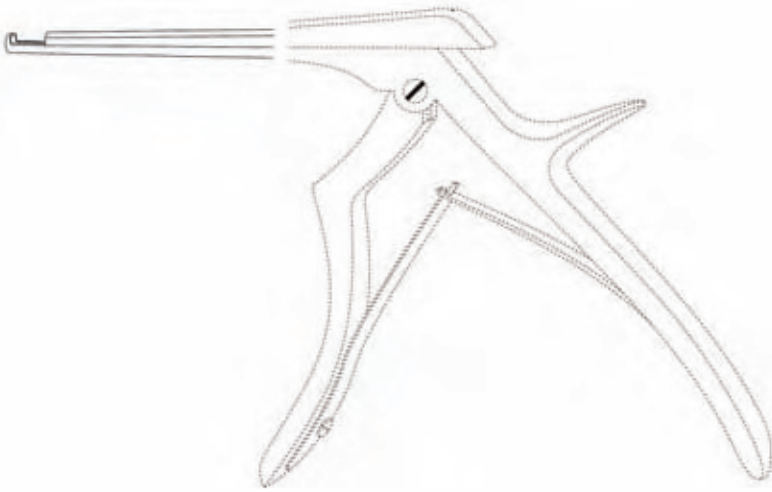

Standardgriff
Standard handle



modifizierter Ringgriff
modified ring handle

LOVE-KERRISON

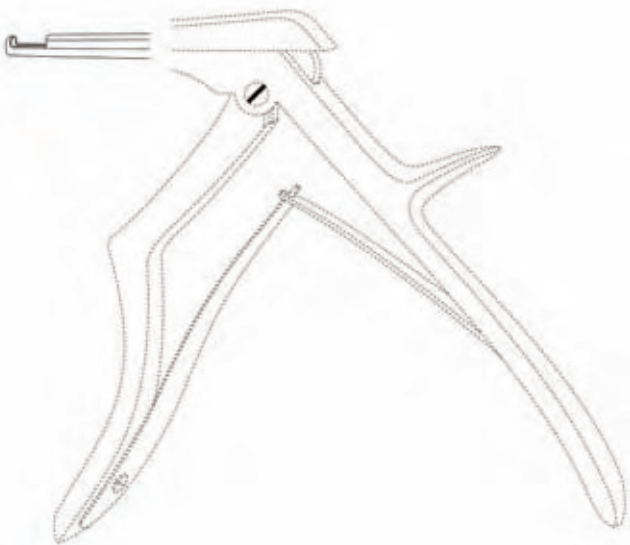

Standardgriff
Standard handle



Hohlkehlengriff
Normal handle

► Wir fertigen bei allen Stanzen das ARBEITSTEIL auf Anfrage, nach Ihren Wünschen.
On demand, the JAWS of all rongeurs can be supplied in any special measurement required.

BAYONET *Instruments*

Individually made for **our customers**

Unser vielseitiges Sortiment an **Bajonett-Instrumenten** macht Ihnen die Arbeit einfacher. Mit diesen Instrumenten haben Sie eine bessere Sicht auf das Operationsfeld, da der Schaft der Instrumente bajonettförmig gebogen ist.

Our wide range of bayonet instruments will simplify your work. These instruments allow a better view into the operation field based on the bayonet shaft.

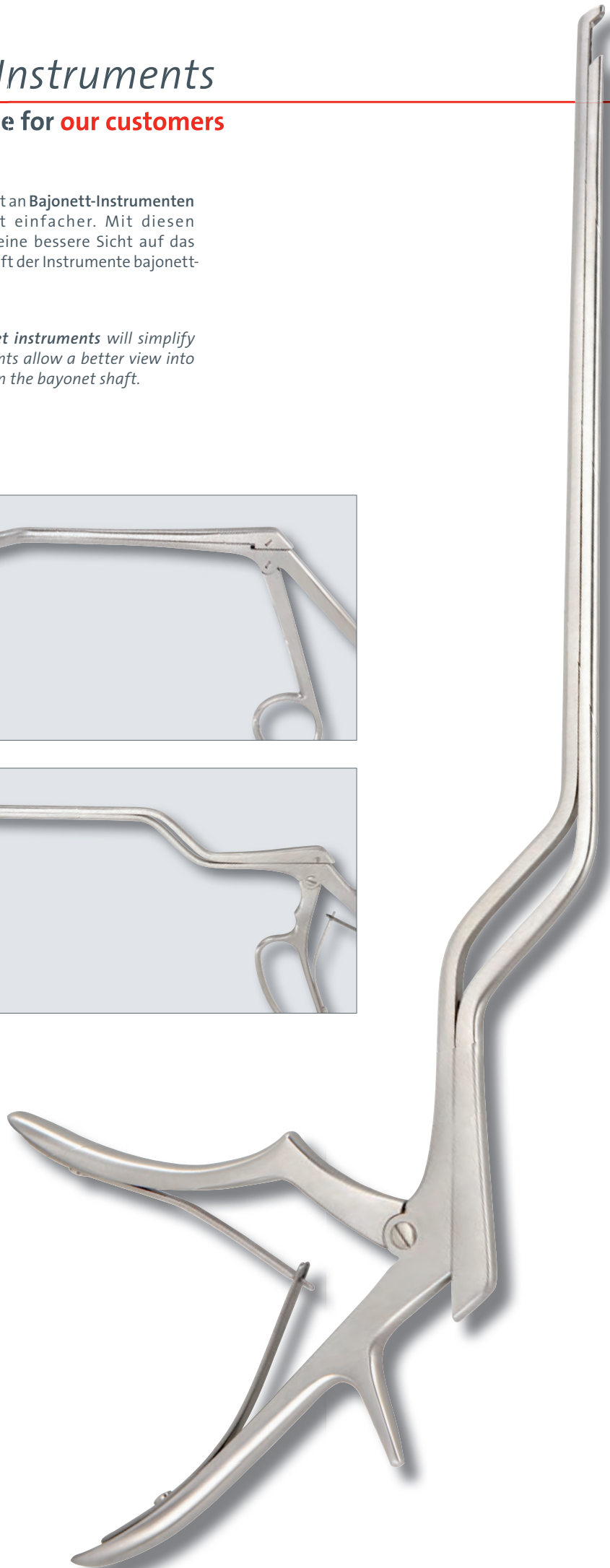

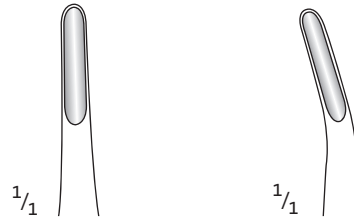
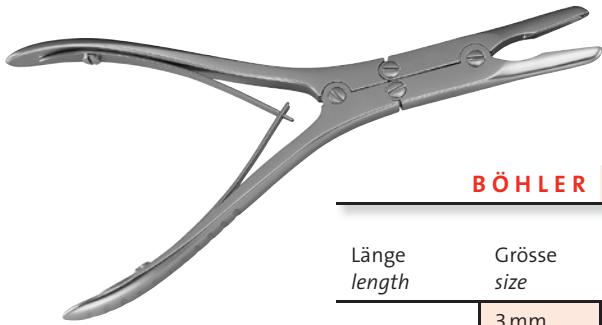

BÖHLER gerade – straight gebogen – curved

Länge length	Grösse size	Bestell-Nr. Ordering No.	Bestell-Nr. Ordering No.
15 cm / 6 inch	3 mm	10-100.03	10-101.03
	4 mm	10-100.04	10-101.04
	5 mm	10-100.05	10-101.05

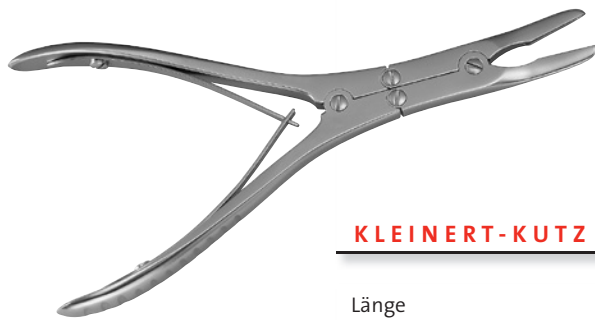

KLEINERT-KUTZ leicht geb. – slightly curved 2x13 mm stark gebogen – full curved 3x8 mm

Länge length	Bestell-Nr. Ordering No.	Bestell-Nr. Ordering No.
15 cm / 6 inch	10-196.02	10-200.03

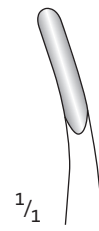
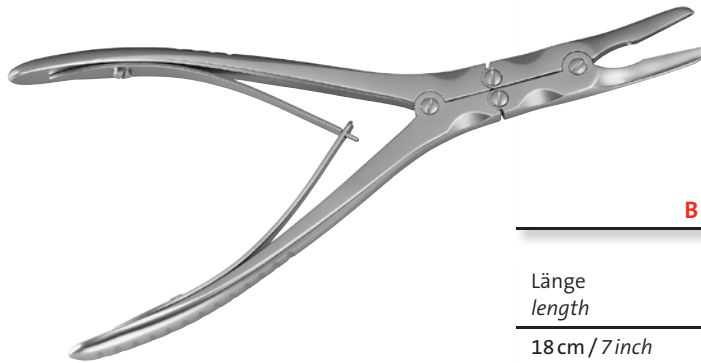

BEYER gebogen—curved

Länge length	Bestell-Nr. Ordering No.
18 cm / 7 inch	10-102.18

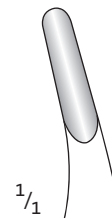
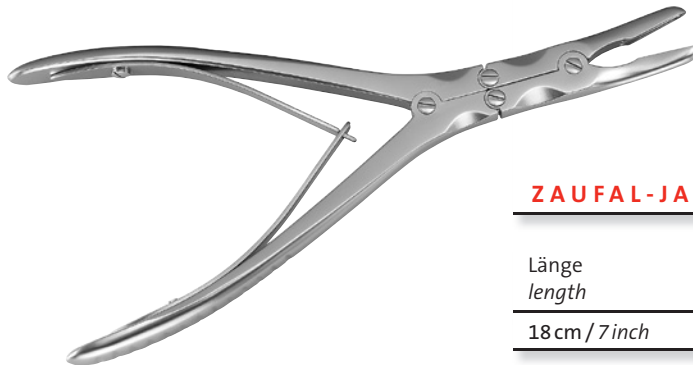

ZAUHAL-JANSEN gebogen—curved

Länge length	Bestell-Nr. Ordering No.
18 cm / 7 inch	10-103.18

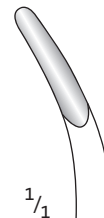
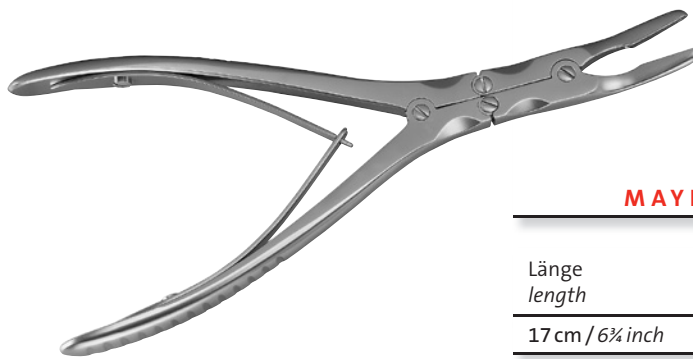

MAYFIELD gebogen—curved

Länge length	Bestell-Nr. Ordering No.
17 cm / 6 1/2 inch	10-204.17

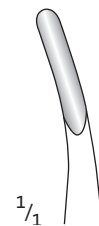

MARQUARDT gebogen—curved

Länge length	Bestell-Nr. Ordering No.
20 cm / 8 inch	10-208.20

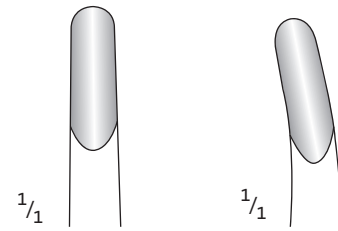
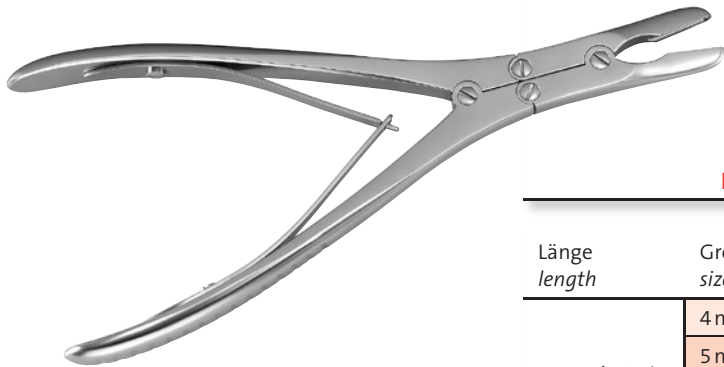

RUSKIN gerade—straight gebogen—curved

Länge length	Grösse size	Bestell-Nr. Ordering No.	Bestell-Nr. Ordering No.
18 cm / 7 inch	4 mm	10-106.04	10-104.04
	5 mm	10-106.05	10-104.05
	6 mm	10-106.06	10-104.06
	7 mm	10-106.07	10-104.07

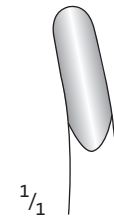
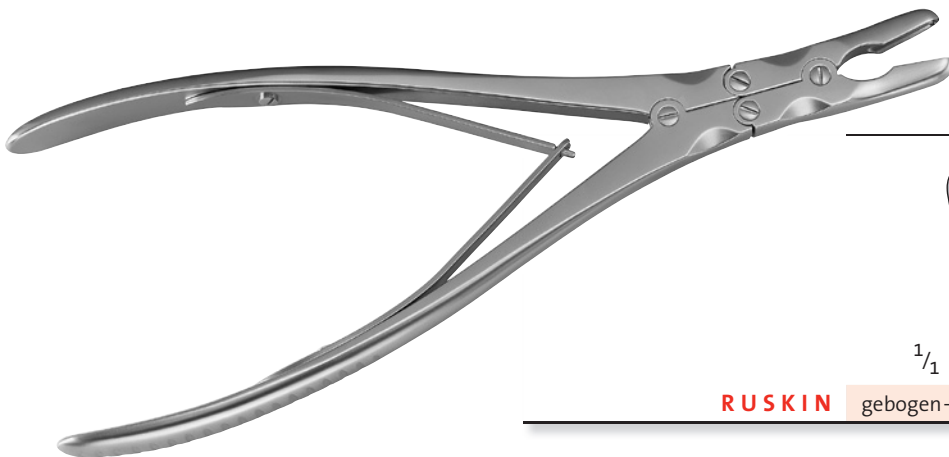

RUSKIN gebogen—curved

Länge length	Grösse size	Bestell-Nr. Ordering No.
23 cm / 9 inch	5 mm	10-108.05
	6 mm	10-108.06
	7 mm	10-108.07

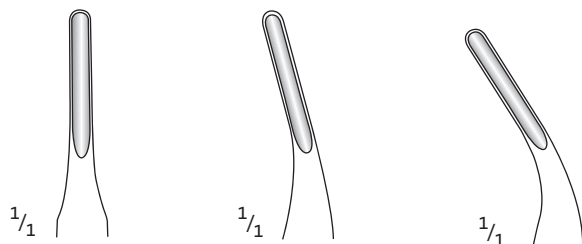
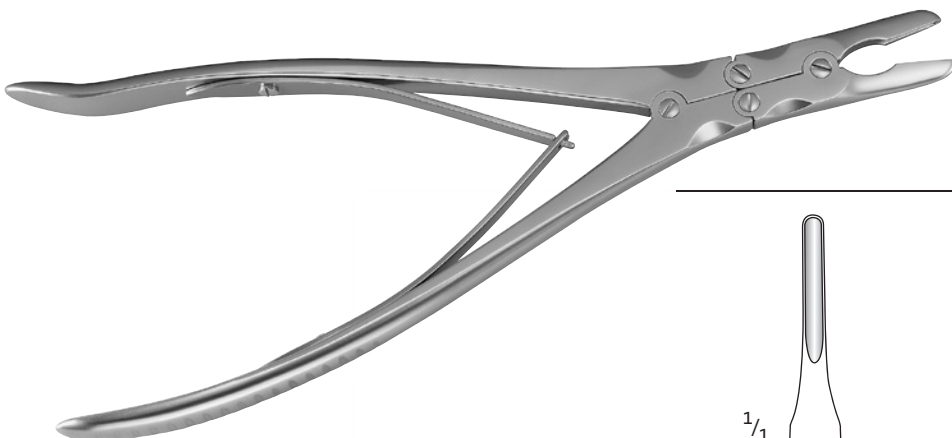

SMITH-PETERSEN gerade—straight gebogen—curved stark geb.—full curved

Länge length	Bestell-Nr. Ordering No.	Bestell-Nr. Ordering No.	Bestell-Nr. Ordering No.
24 cm / 9½ inch	10-131.24	10-132.24	10-133.24

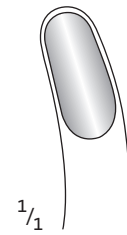
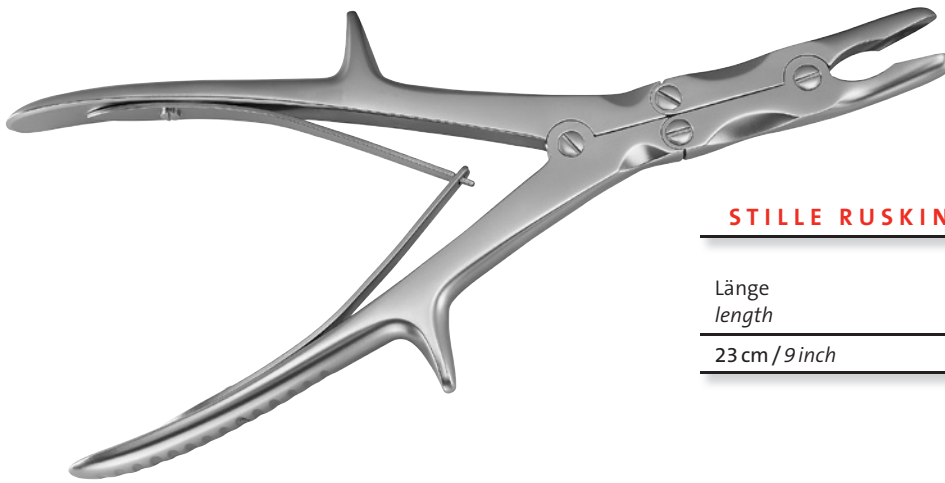

STILLE RUSKIN gebogen – curved

Länge
length

Bestell-Nr.
Ordering No.

23 cm / 9 inch

10-114.23



FRYKHOLM gebogen – curved

Länge
length

Bestell-Nr.
Ordering No.

24 cm / 9½ inch

10-220.24

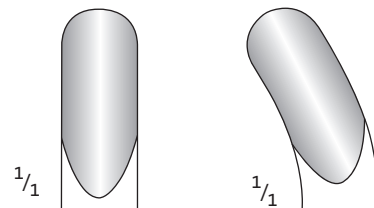
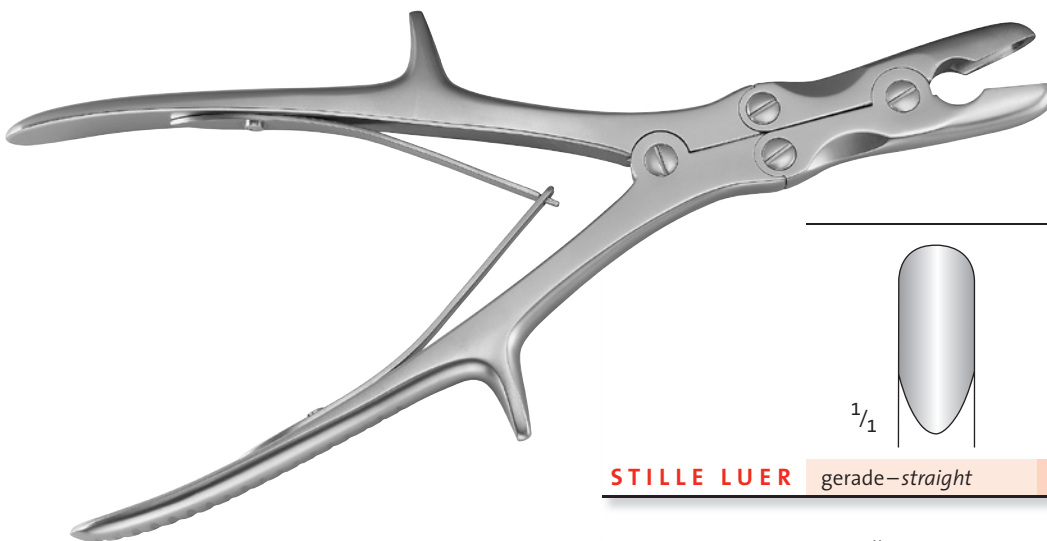

STILLE LUER gerade – straight gebogen – curved

Länge
length

Bestell-Nr.
Ordering No.

Bestell-Nr.
Ordering No.

22 cm / 8½ inch

10-113.22

10-112.22

26 cm / 10½ inch

10-113.26

10-112.26

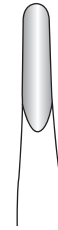
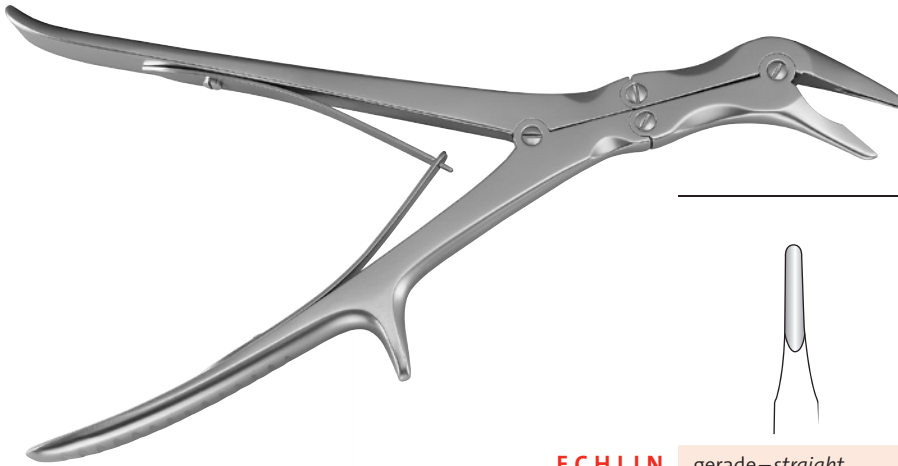

ECHLIN gerade-straight gerade-straight gerade-straight

Länge length	Maulbreite bite	Bestell-Nr. Ordering No.	Bestell-Nr. Ordering No.	Bestell-Nr. Ordering No.
23 cm / 9 inch	2x10 mm	10-115.23	-	-
	3x10 mm	-	10-116.23	-
	4x10 mm	-	-	10-117.23

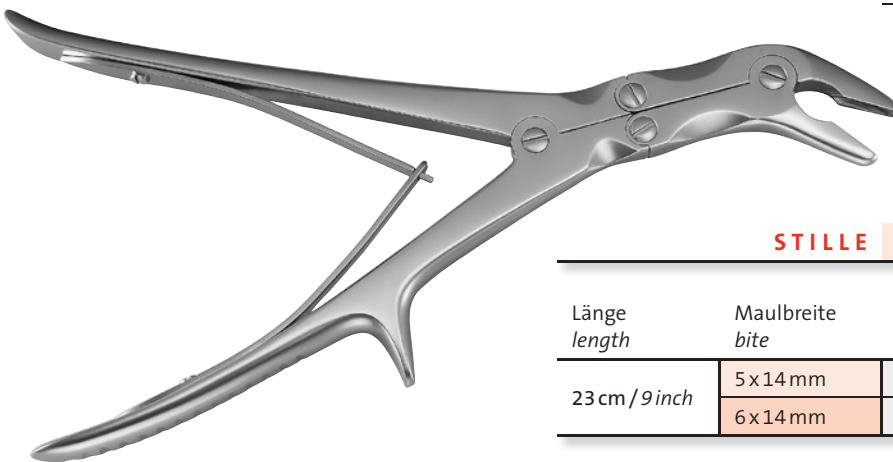

STILLE gerade-straight gerade-straight

Länge length	Maulbreite bite	Bestell-Nr. Ordering No.	Bestell-Nr. Ordering No.
23 cm / 9 inch	5x14 mm	10-111.05	-
	6x14 mm	-	10-111.06

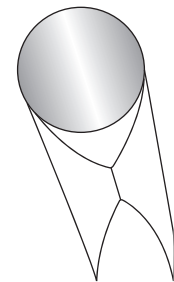
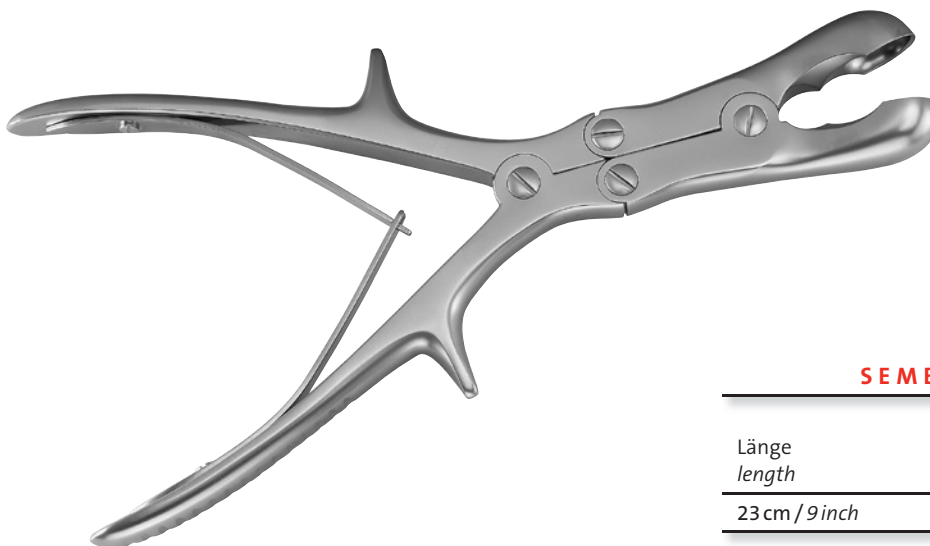

SEMB gebogen-curved

Länge length	Bestell-Nr. Ordering No.
23 cm / 9 inch	10-118.23

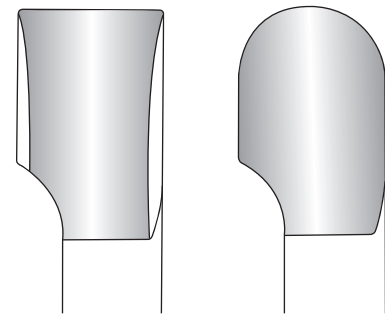
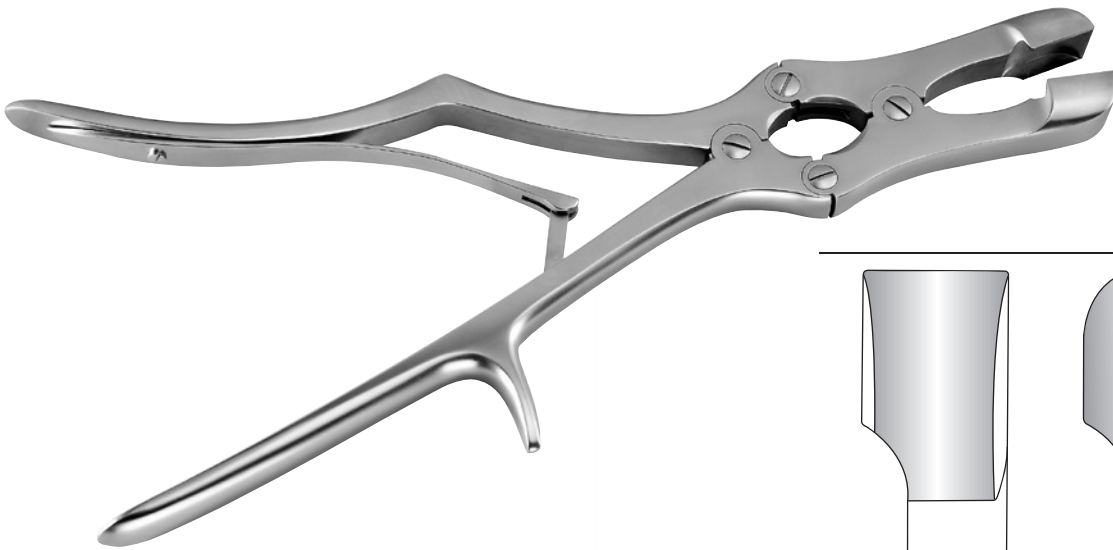

SAUERBRUCH gerade-straight gerade-straight

Länge length	Bestell-Nr. Ordering No.	Bestell-Nr. Ordering No.
31 cm / 12 ³ / ₈ inch	10-120.31	10-119.31

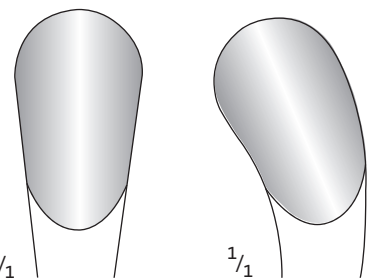
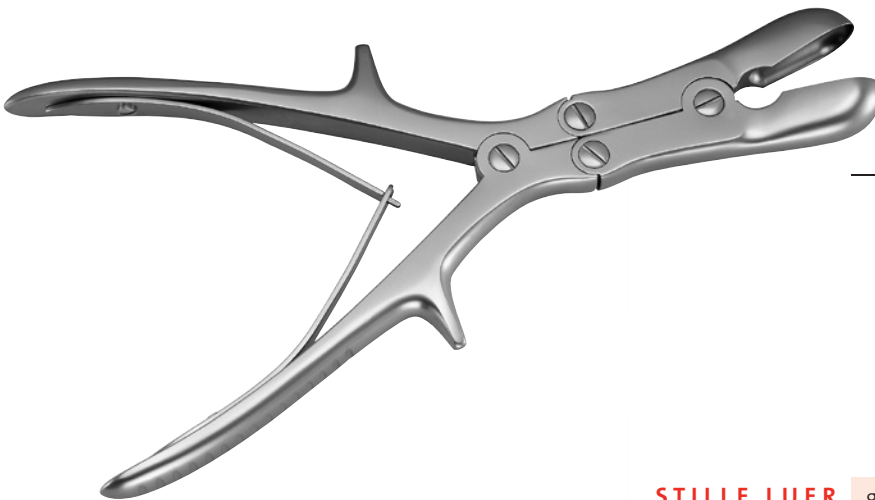

STILLE LUER gerade-straight gebogen-curved

Länge length	Bestell-Nr. Ordering No.	Bestell-Nr. Ordering No.
22 cm / 8 ¹ / ₂ inch	10-113.23	10-112.23
27 cm / 10 ¹ / ₂ inch	10-113.27	10-112.27

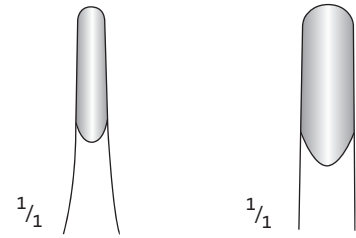
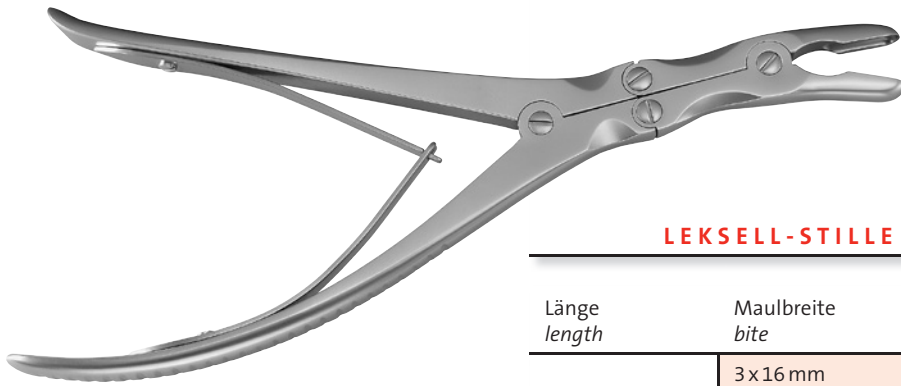

LEKSELL-STILLE

3 mm

8 mm

Länge length	Maulbreite bite	Bestell-Nr. Ordering No.
24 cm / 9½ inch	3 x 16 mm	10-110.03
	4 x 16 mm	10-110.04
	5 x 16 mm	10-110.05
	6 x 16 mm	10-110.06
	7 x 16 mm	10-110.07
	8 x 16 mm	10-110.08

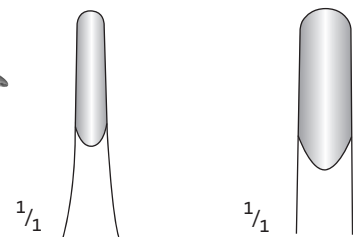
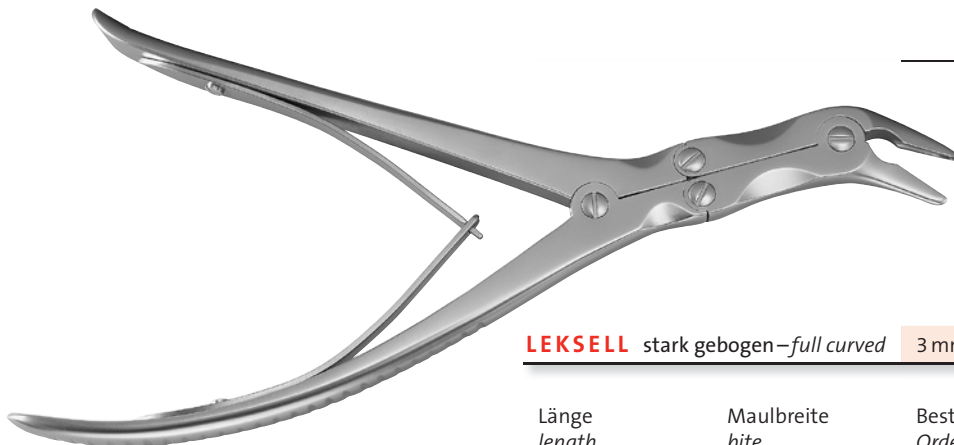

LEKSELL stark gebogen - full curved

3 mm

8 mm

Länge length	Maulbreite bite	Bestell-Nr. Ordering No.
24 cm / 9½ inch	3 x 16 mm	10-210.03
	4 x 16 mm	10-210.04
	5 x 16 mm	10-210.05
	6 x 16 mm	10-210.06
	7 x 16 mm	10-210.07
	8 x 16 mm	10-210.08



DALE 3 mm

Länge length	Bestell-Nr. Ordering No.
34 cm / 13 ² / ₃ inch	10-156.03



SYPERT ohne Zähne – without teeth mit Zähne – with teeth

Länge length	Maulbreite bite	Bestell-Nr. Ordering No.	Bestell-Nr. Ordering No.
36 cm / 14 ³ / ₈ inch	4 mm	10-145.04	–
	5 mm	10-145.05	–
	8 mm	10-145.08	10-150.08
	12 mm	10-145.12	10-150.12

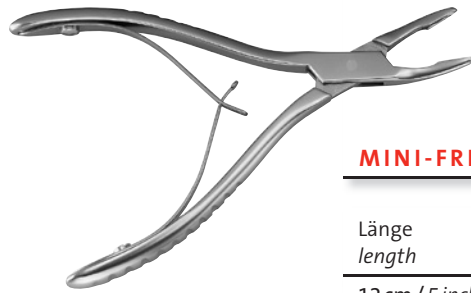

MINI-FRIEDMANN gebogen – curved

Länge length	Bestell-Nr. Ordering No.
12 cm / 5 inch	10-140.12

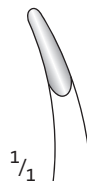
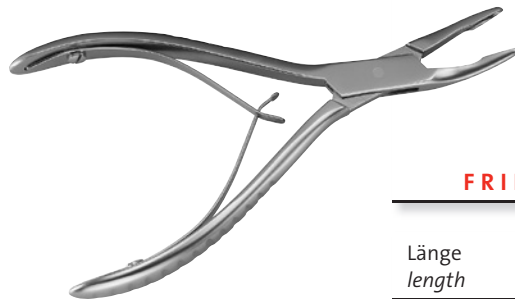

FRIEDMANN gebogen – curved

Länge length	Bestell-Nr. Ordering No.
14 cm / 5½ inch	10-144.14

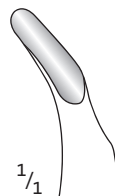
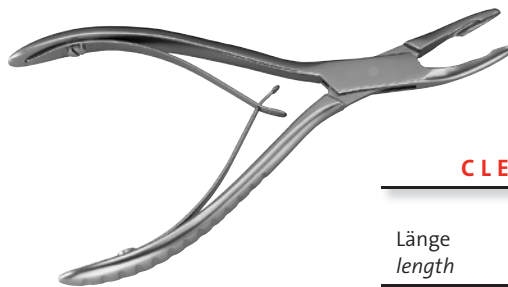

CLEVELAND gebogen – curved

Länge length	Bestell-Nr. Ordering No.
14 cm / 5½ inch	10-148.14

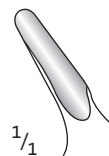
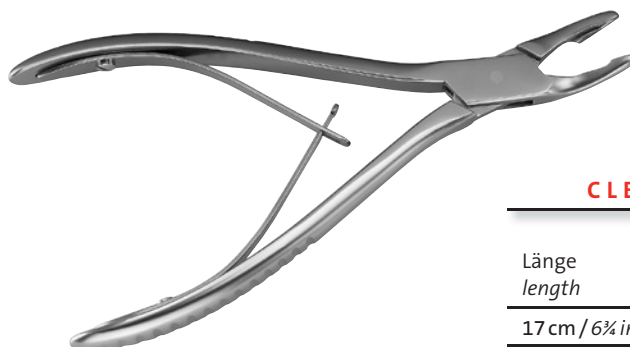

CLEVELAND gebogen – curved

Länge length	Bestell-Nr. Ordering No.
17 cm / 6¾ inch	10-152.17

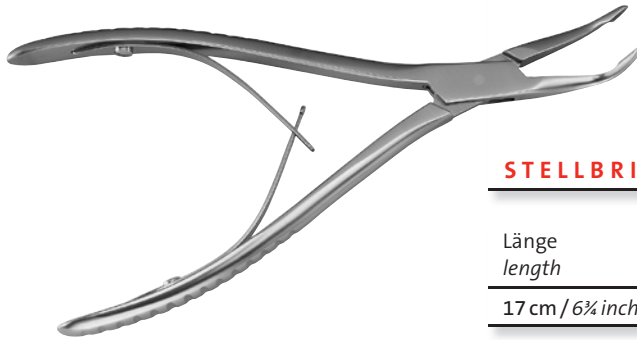

STELLBRINK 2 mm 2 mm

Länge length	Bestell-Nr. Ordering No.	Bestell-Nr. Ordering No.
17 cm / 6 3/4 inch	10-156.01	10-156.02

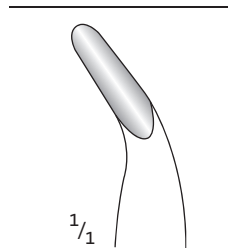
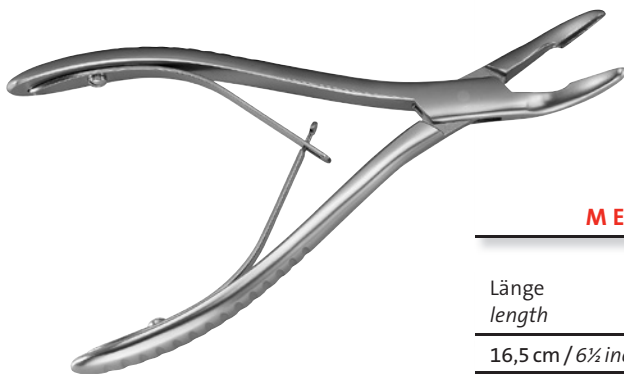

MEAD gebogen - curved

Länge length	Bestell-Nr. Ordering No.
16,5 cm / 6 1/2 inch	10-160.16

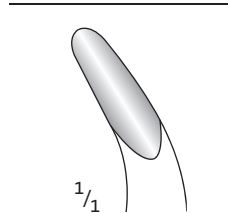

HARTMANN gebogen - curved

Länge length	Bestell-Nr. Ordering No.
18,5 cm / 7 1/4 inch	10-134.18

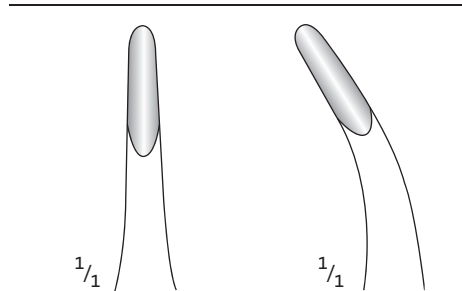
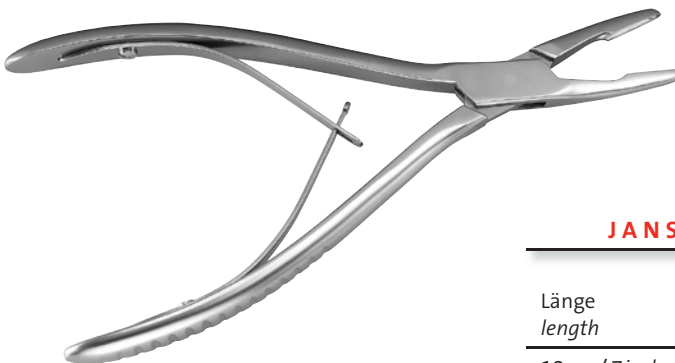

JANZEN gerade - straight gebogen - curved

Länge length	Bestell-Nr. Ordering No.	Bestell-Nr. Ordering No.
18 cm / 7 inch	10-128.18	10-129.18

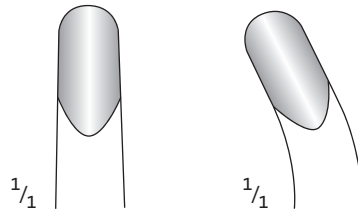
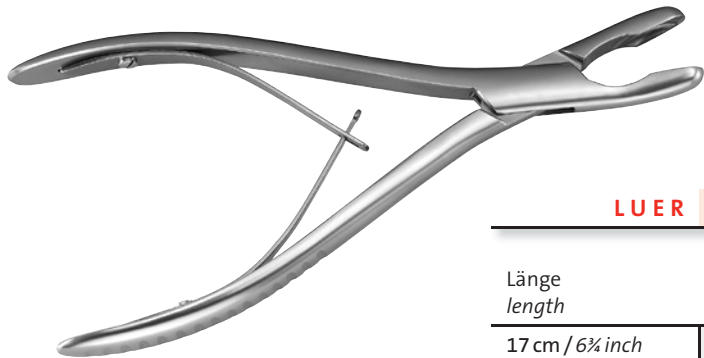

LUER gerade – straight gebogen – curved

Länge length	Bestell-Nr. Ordering No.	Bestell-Nr. Ordering No.
17 cm / 6½ inch	10-122.17	10-123.17

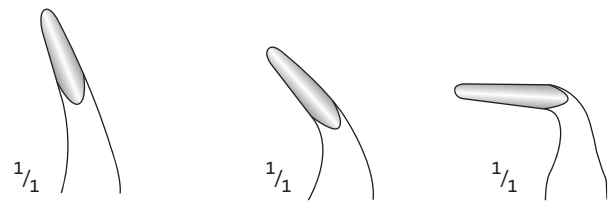
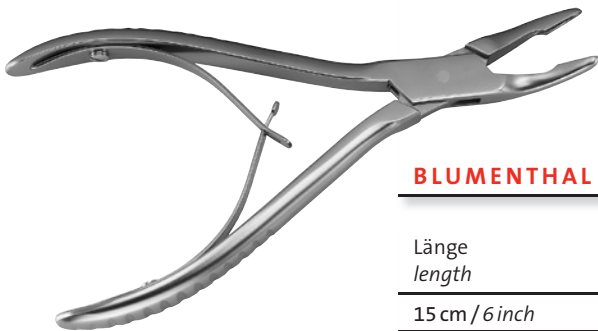

BLUMENTHAL 30° gebogen – curved 45° gebogen – curved 90° gebogen – curved

Länge length	Bestell-Nr. Ordering No.	Bestell-Nr. Ordering No.	Bestell-Nr. Ordering No.
15 cm / 6 inch	10-172.15	10-176.15	10-180.15

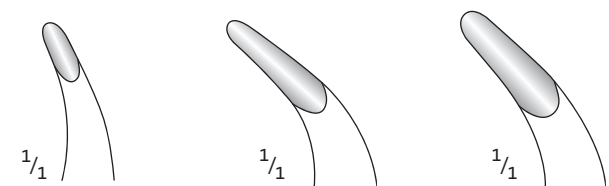
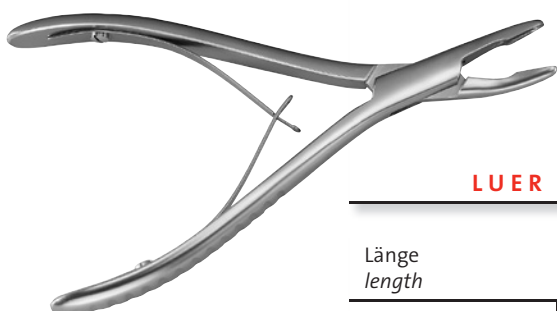

LUER gebogen – curved gebogen – curved gebogen – curved

Länge length	Bestell-Nr. Ordering No.	Bestell-Nr. Ordering No.	Bestell-Nr. Ordering No.
15 cm / 6 inch	10-184.15	10-188.15	10-192.15

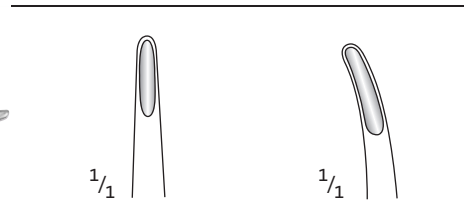
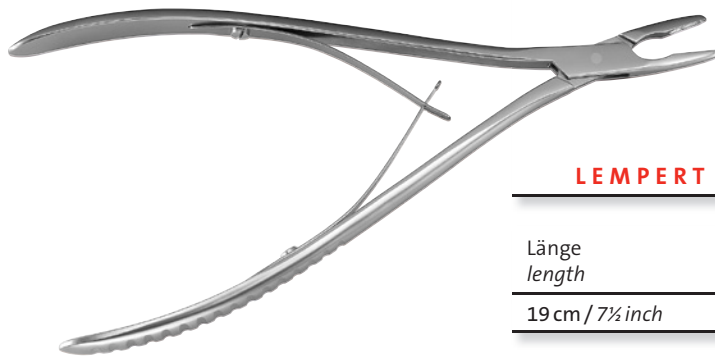

LEMPERT gerade-straight gebogen-curved

Länge length	Bestell-Nr. Ordering No.	Bestell-Nr. Ordering No.
19 cm / 7½ inch	10-124.19	10-125.19

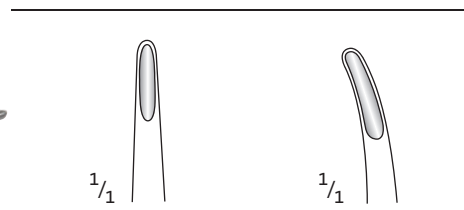

LEMPERT gerade-straight gebogen-curved

Länge length	Bestell-Nr. Ordering No.	Bestell-Nr. Ordering No.
16 cm / 6½ inch	10-126.16	10-127.16

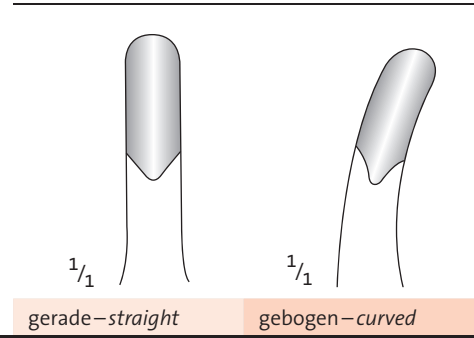
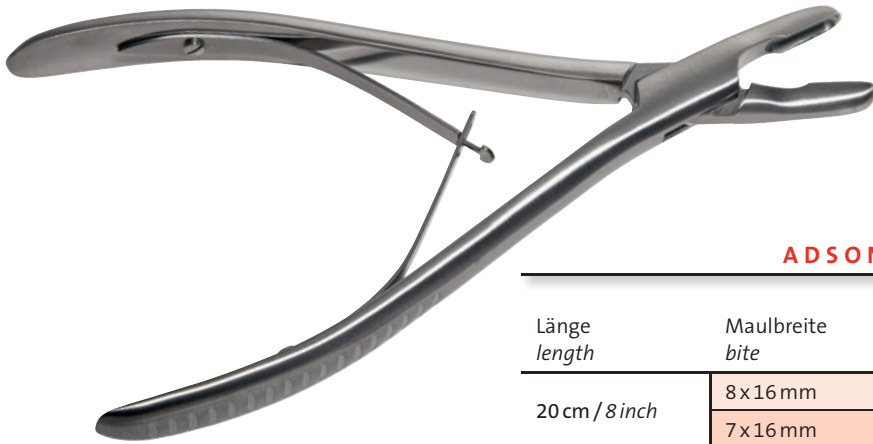

ADSON gerade—straight gebogen—curved

Länge length	Maulbreite bite	Bestell-Nr. Ordering No.	Bestell-Nr. Ordering No.
20 cm / 8 inch	8 x 16 mm	10-135.20	10-136.20
	7 x 16 mm	10-137.20	10-138.20

ADSON mit Zähne—with teeth

Länge length	Bestell-Nr. Ordering No.
20 cm / 8 inch	20-221.20

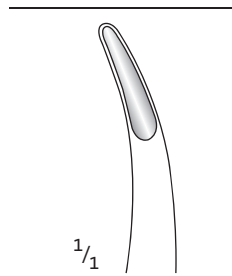
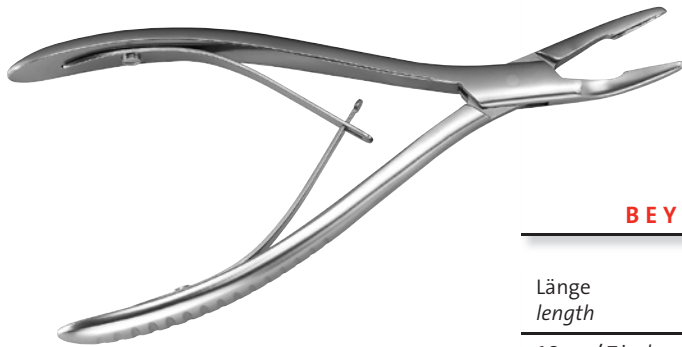

BEYER gebogen—curved

Länge length	Bestell-Nr. Ordering No.
18 cm / 7 inch	10-130.18

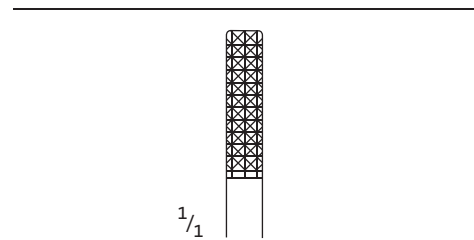
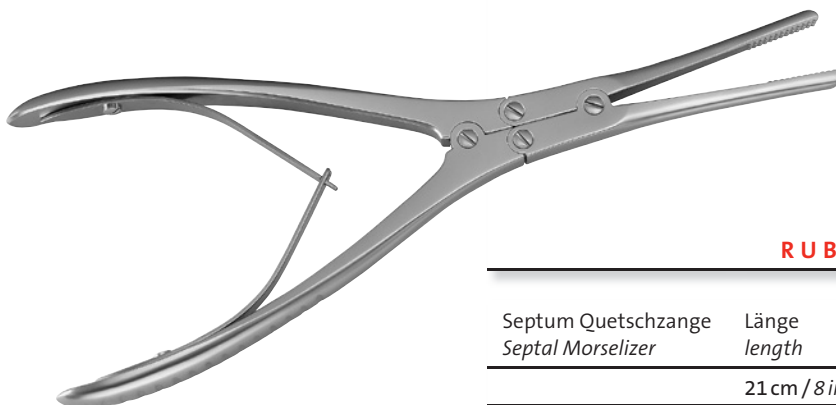

RUBIN gerade—straight gebogen—curved

Septum Quetschzange Septal Morselizer	Länge length	Bestell-Nr. Ordering No.	Bestell-Nr. Ordering No.
	21 cm / 8 inch	20-219.21	20-220.21

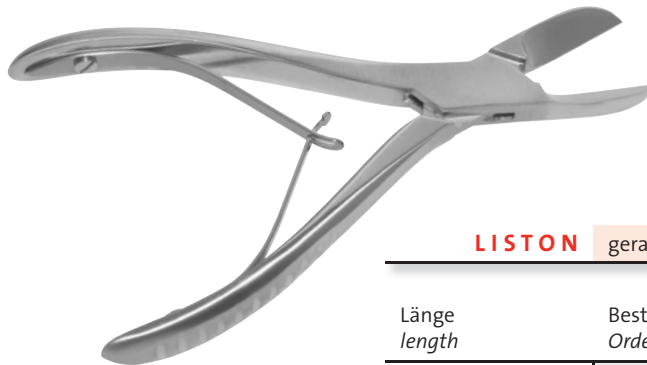

LISTON gerade—straight gebogen—curved

Länge length	Bestell-Nr. Ordering No.	Bestell-Nr. Ordering No.
14 cm / 5½ inch	20-100.14	20-110.14
17 cm / 6¾ inch	20-100.17	20-110.17
19 cm / 7½ inch	20-100.19	20-110.19
22 cm / 8¾ inch	20-100.22	20-110.22

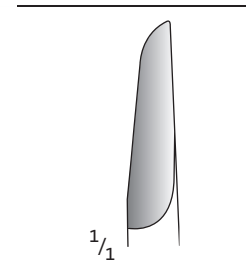
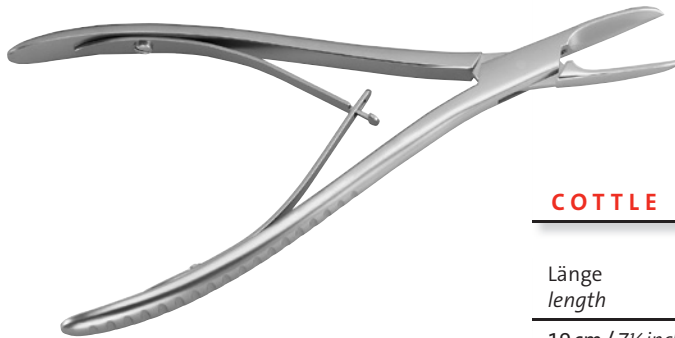

COTTLE KAZANJIAN gerade—straight

Länge length	Bestell-Nr. Ordering No.
19 cm / 7½ inch	20-150.19

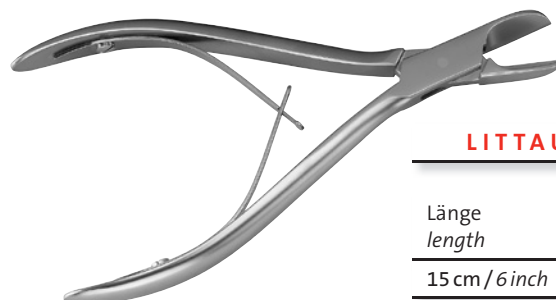

LITTAUER

Länge length	Bestell-Nr. Ordering No.
15 cm / 6 inch	20-152.15

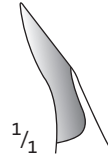
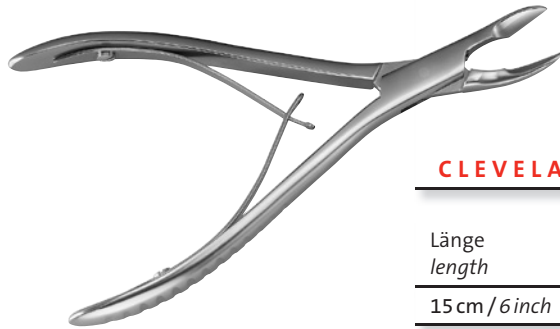

CLEVELAND gebogen – curved

Länge length	Bestell-Nr. Ordering No.
15 cm / 6 inch	20-158.15

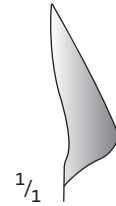
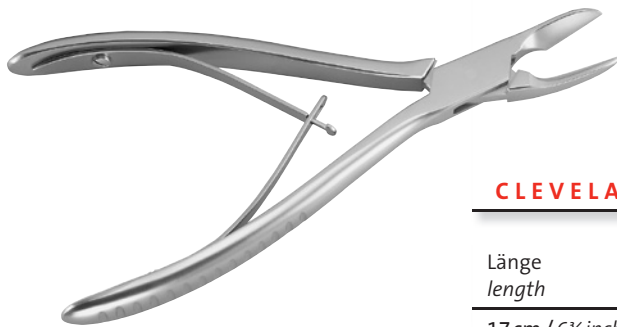

CLEVELAND gebogen – curved

Länge length	Bestell-Nr. Ordering No.
17 cm / 6 1/4 inch	20-154.17

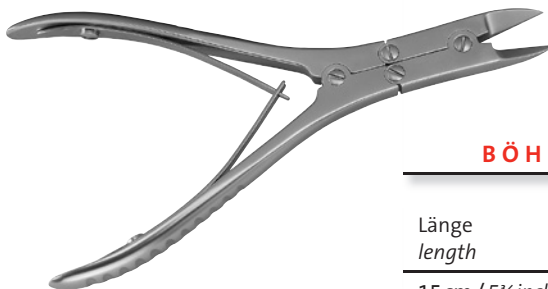

BÖHLER gerade – straight gebogen – curved

Länge length	Bestell-Nr. Ordering No.	Bestell-Nr. Ordering No.
15 cm / 5 1/4 inch	20-200.15	20-201.15

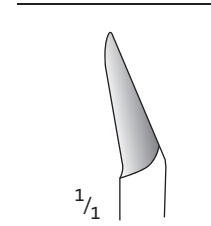

MC INDOE gebogen – curved

Länge
length

17,5 cm / 7 inch

Bestell-Nr.
Ordering No.

20-203.18

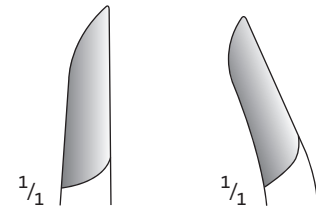
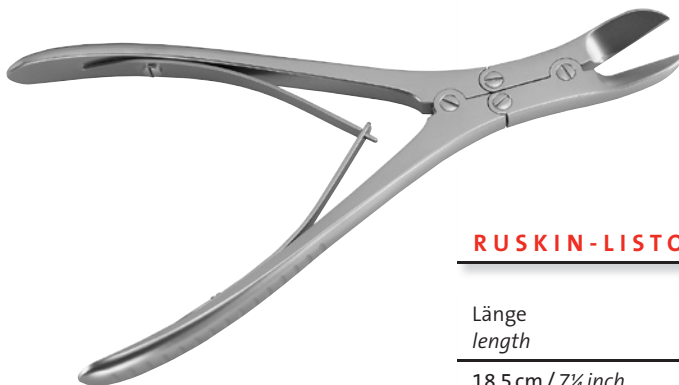

RUSKIN-LISTON gerade – straight gebogen – curved

Länge
length

18,5 cm / 7 1/4 inch

Bestell-Nr.
Ordering No.

20-204.18

Bestell-Nr.
Ordering No.

20-205.18

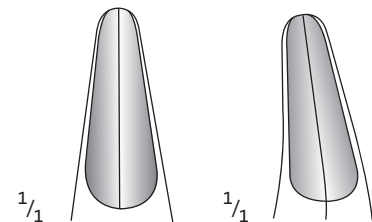
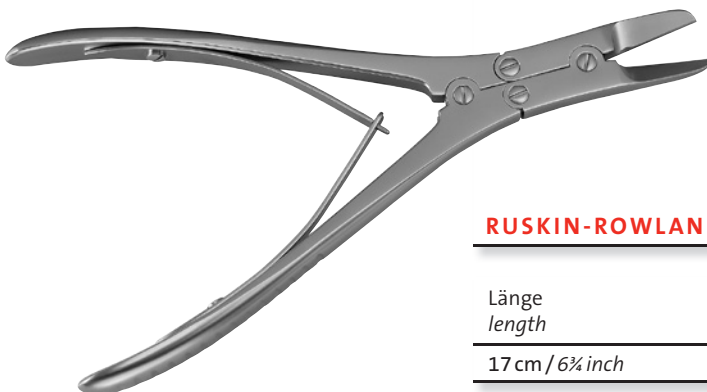

RUSKIN-ROWLAND gerade – straight gebogen – curved

Länge
length

17 cm / 6 3/4 inch

Bestell-Nr.
Ordering No.

20-214.17

Bestell-Nr.
Ordering No.

20-215.17

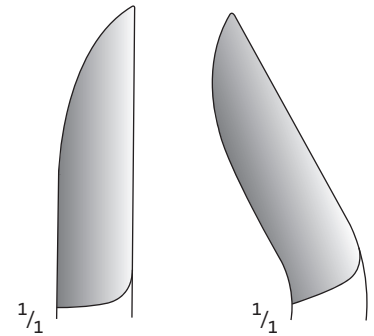
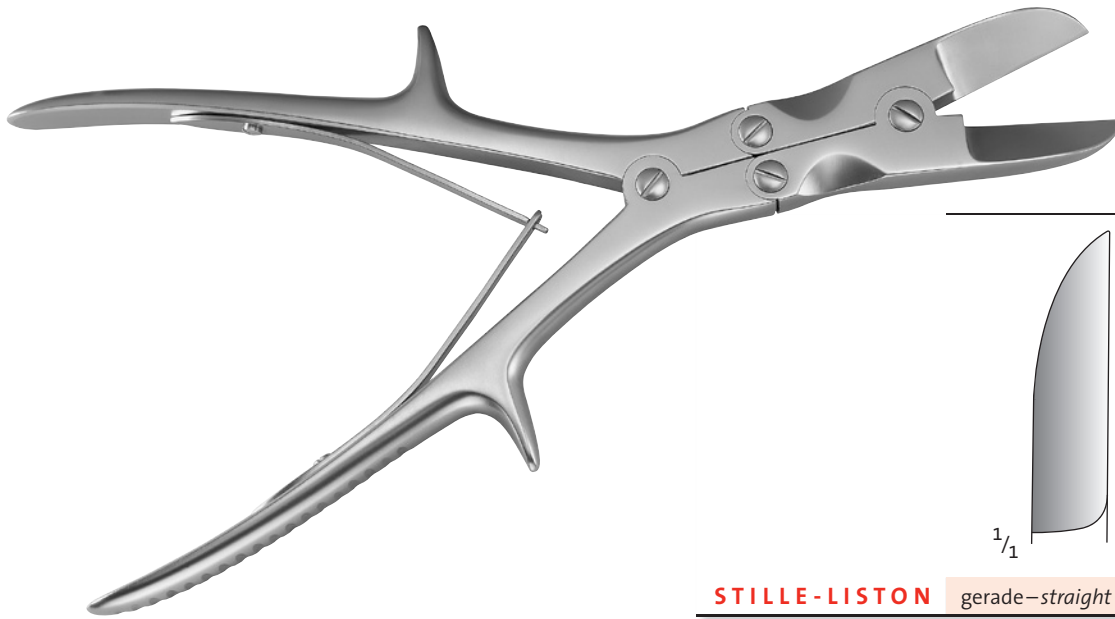

STILLE-LISTON gerade—straight gebogen—curved

Länge length	Bestell-Nr. Ordering No.	Bestell-Nr. Ordering No.
23 cm / 9 inch	20-206.23	20-207.23
27 cm / 10½ inch	20-206.27	20-207.27

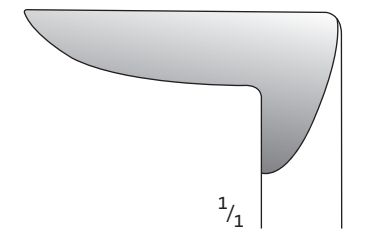
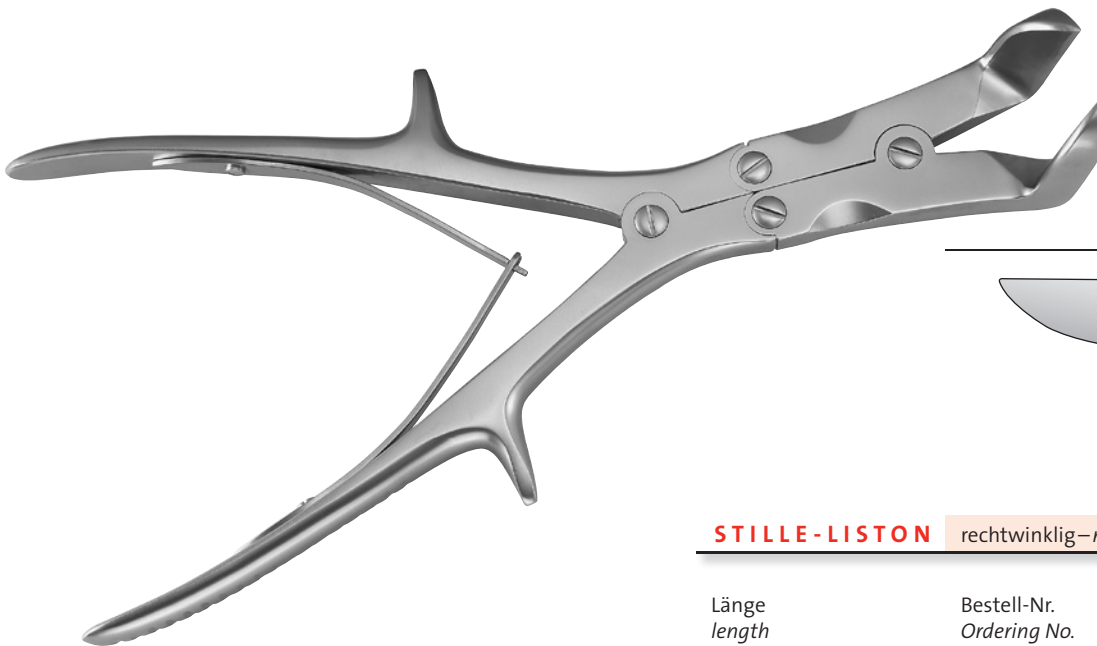

STILLE-LISTON rechtwinklig—right-angled

Länge length	Bestell-Nr. Ordering No.
27 cm / 10½ inch	20-208.26

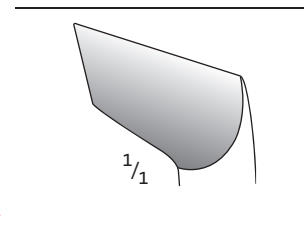

LISTON-KEY

Länge length	Bestell-Nr. Ordering No.
27 cm / 10½ inch	20-209.27

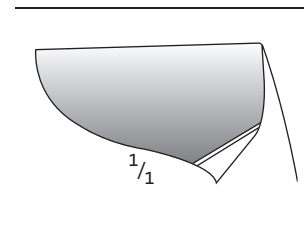
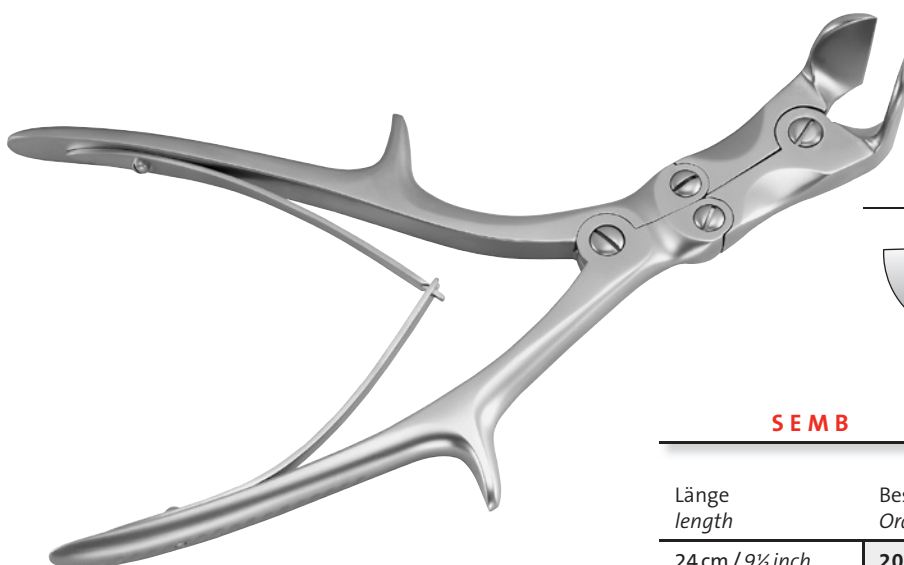

SEMB

Länge length	Bestell-Nr. Ordering No.
24 cm / 9½ inch	20-210.25



VERBRÜGGE

Knochenhaltezange <i>Bone holding Forceps</i>	Länge <i>length</i>	Bestell-Nr. <i>Ordering No.</i>
	17,5 cm / 6 7/8 inch	95-290.00

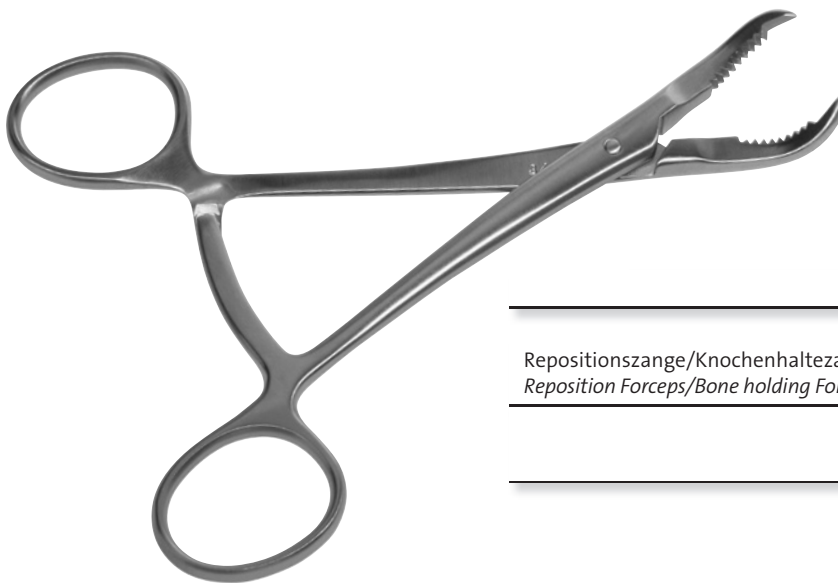

Repositionszange/Knochenhaltezange <i>Reposition Forceps/Bone holding Forceps</i>	Länge <i>length</i>	Bestell-Nr. <i>Ordering No.</i>
	14,5 cm / 5 7/8 inch	95-299.00



Repositionszange <i>Reposition Forceps</i>	Länge <i>length</i>	Bestell-Nr. <i>Ordering No.</i>
	24 cm / 9 1/2 inch	95-292.00

▶ andere Ausführungen auf Anfrage
other specifications upon request

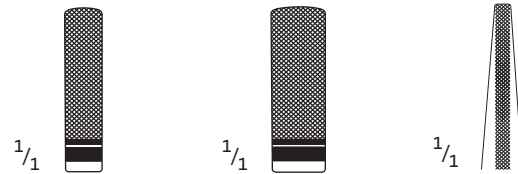
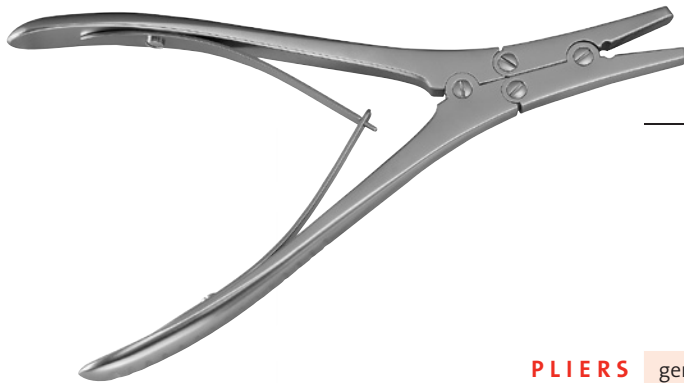

PLIERS gerade-straight gerade-straight gerade-straight

ohne Hartmetall without TC-inserts	Länge length	Bestell-Nr. Ordering No.	Bestell-Nr. Ordering No.	Bestell-Nr. Ordering No.
	18 cm / 7 inch	30-105.05	30-105.07	30-105.20

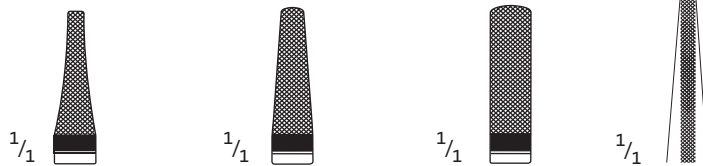

PLIERS gerade-straight gerade-straight gerade-straight gerade-straight

mit Hartmetall with TC-inserts	Länge length	Bestell-Nr. Ordering No.	Bestell-Nr. Ordering No.	Bestell-Nr. Ordering No.	Bestell-Nr. Ordering No.
	18 cm / 7 inch	30-102.01	30-102.03	30-102.05	30-102.06



Kirschner Drahtzange
Kirschner wire plier

Länge
length

Bestell-Nr.
Ordering No.

17 cm / 6 3/4 inch

95-254.01

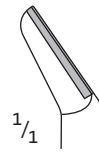

TC-Drahtschneidezange TC wire cutting pliers	Länge length	Bestell-Nr. Ordering No.
für weichen Draht bis 2,0 mm Ø for soft wire up to 2.0 mm Ø für harten Draht bis 1,7 mm Ø for hard wire up to 1.7 mm diam.	18 cm / 7 inch	30-100.18

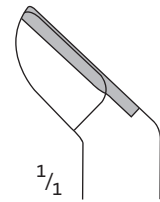

TC-Drahtschneidezange TC wire cutting pliers	Länge length	Bestell-Nr. Ordering No.
für weichen Draht bis 3,0 mm Ø for soft wire up to 3.0 mm Ø für harten Draht bis 2,5 mm Ø for hard wire up to 2.5 mm diam.	22 cm / 8½ inch	30-101.22

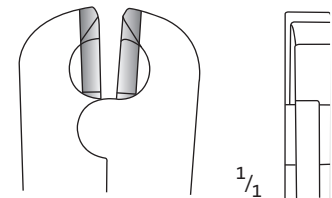

glatt schneidend
smooth cutting

TC-Kopf und Seitenschneider TC side and end cutter	Länge length	Bestell-Nr. Ordering No.	Bestell-Nr. Ordering No.
für harten Draht bis 1,7 mm Ø for hard wire up to 1.7 mm diam.	18 cm / 7 inch	30-103.18	30-103.17

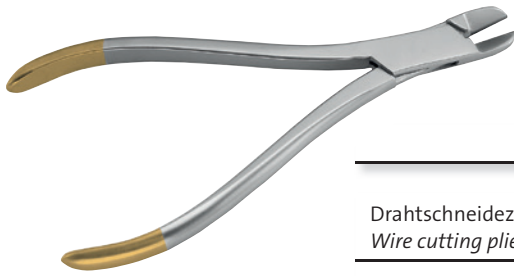

Drahtschneidezange mit Hartmetall <i>Wire cutting pliers with tungsten carbide</i>	Länge <i>length</i>	Bestell-Nr. <i>Ordering No.</i>
für harten Draht bis 0,6 mm Ø <i>for hard wire up to 0.6 mm diam.</i>	14 cm / 5½ inch	30-119.14



Drahtschneidezange mit Hartmetall <i>Wire cutting pliers with tungsten carbide</i>	Länge <i>length</i>	Bestell-Nr. <i>Ordering No.</i>
für harten Draht bis 0,6 mm Ø <i>for hard wire up to 0.6 mm diam.</i>	12,5 cm / 5 inch	30-118.12

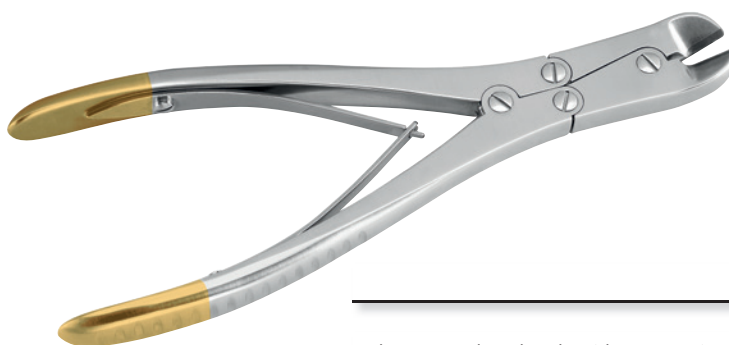

Platten- und Drahtschneidezange mit Hartmetall <i>Plate- and wire cutting pliers with tungsten carbide</i>	Länge <i>length</i>	Bestell-Nr. <i>Ordering No.</i>
für Draht bis 1,7 mm Ø <i>for wire up to 1.7 mm diam.</i>	18 cm / 7 inch	30-121.18



TC Seitenschneider mit Hartmetall <i>TC end cutter with tungsten carbide</i>	Länge <i>length</i>	Bestell-Nr. <i>Ordering No.</i>
für weichen Draht bis 3,0 mm Ø für harten Draht bis 2,2 mm Ø <i>for soft wire up to 3,0 mm Ø for hard wire up to 2,2 mm Ø</i>	22 cm / 8½ inch	95-250.01TC

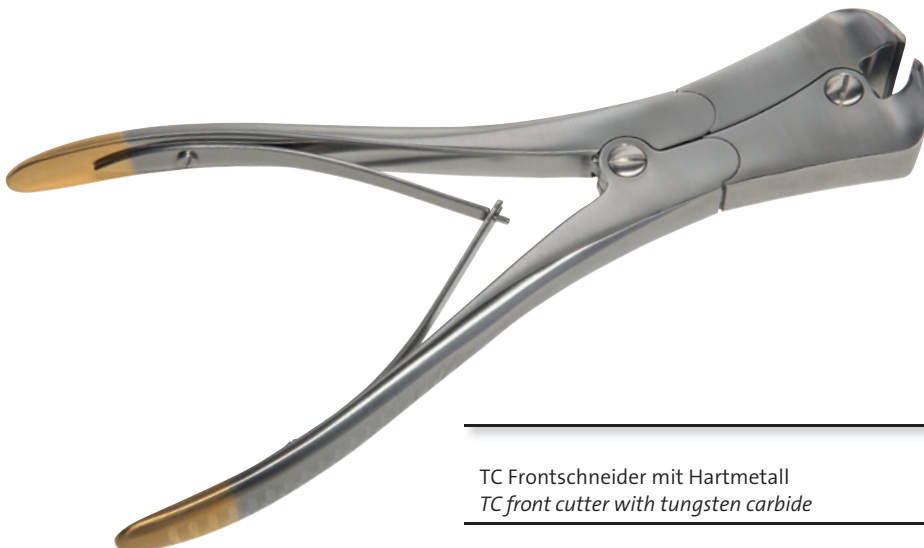

TC Frontschneider mit Hartmetall <i>TC front cutter with tungsten carbide</i>	Länge <i>length</i>	Bestell-Nr. <i>Ordering No.</i>
für weichen Draht bis 3,0 mm Ø für harten Draht bis 2,5 mm Ø <i>for soft wire up to 3,0 mm Ø for hard wire up to 2,5 mm Ø</i>	22 cm / 8½ inch	95-250.05

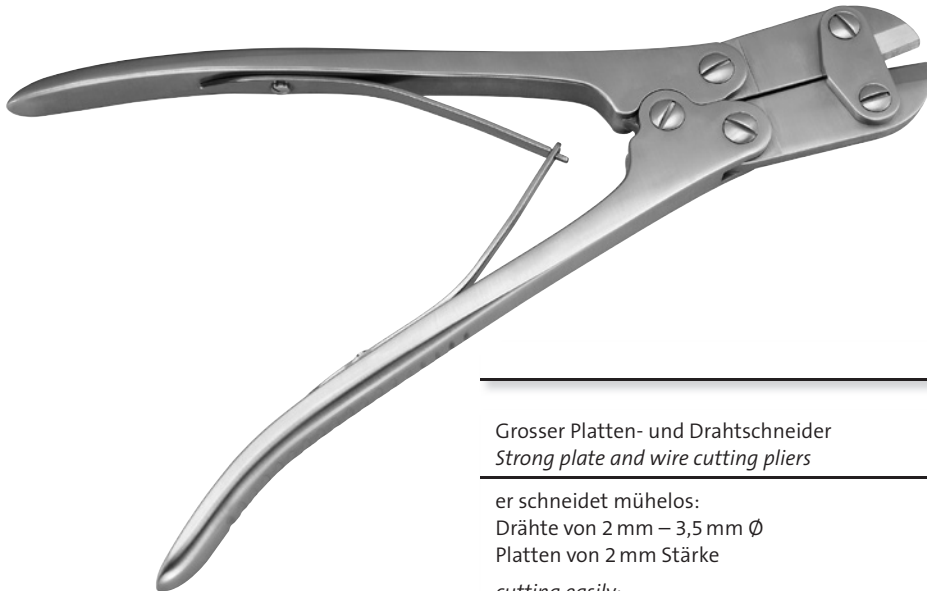

Grosser Platten- und Drahtschneider <i>Strong plate and wire cutting pliers</i>	Länge <i>length</i>	Bestell-Nr. <i>Ordering No.</i>
er schneidet mühelos: Drähte von 2 mm – 3,5 mm Ø Platten von 2 mm Stärke <i>cutting easily: wires from 2 mm to 3.5 mm diam. plates with 2 mm thickness</i>	24 cm / 9½ inch	30-110.24

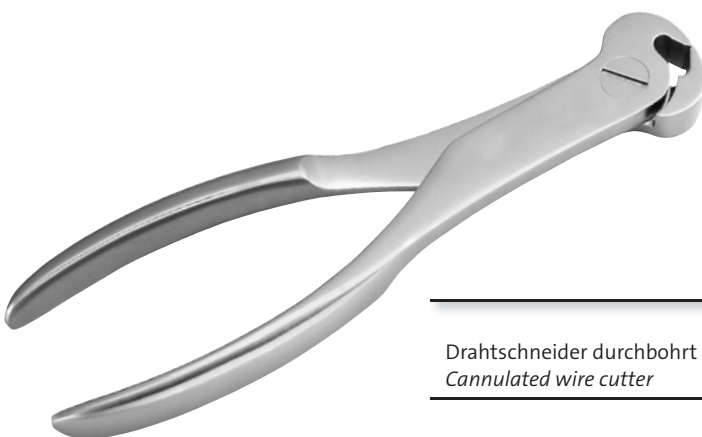

Drahtschneider durchbohrt <i>Cannulated wire cutter</i>	Länge <i>length</i>	Bestell-Nr. <i>Ordering No.</i>
für weichen Draht bis 2,0 mm Ø für harten Draht bis 1,7 mm Ø <i>for soft wire up to 2,0 mm Ø for hard wire up to 1,7 mm Ø</i>	18 cm / 7 inch	30-090.18

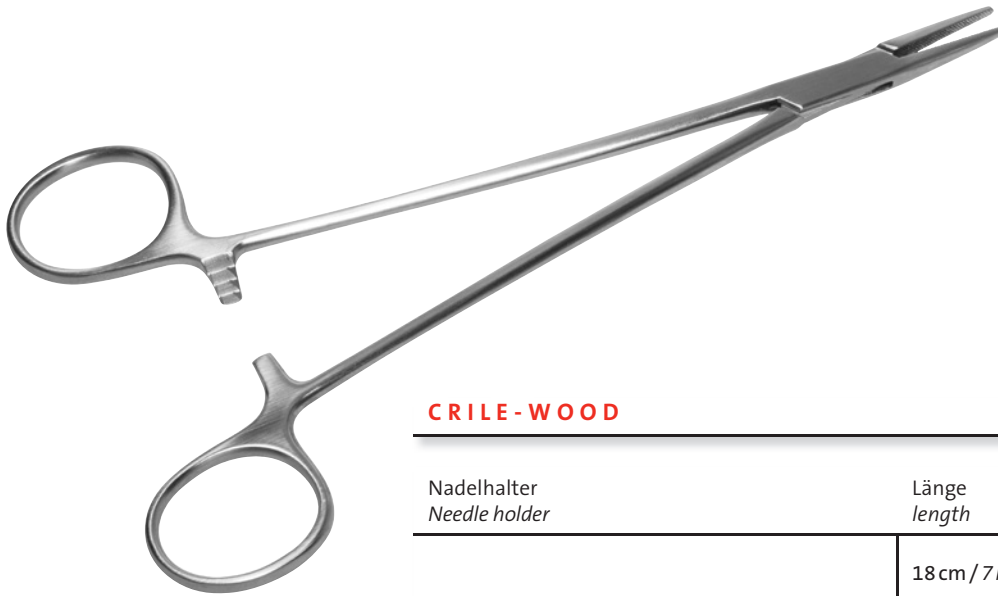

CRILE-WOOD

Nadelhalter Needle holder	Länge length	Bestell-Nr. Ordering No.
	18 cm / 7 inch	05-013.18

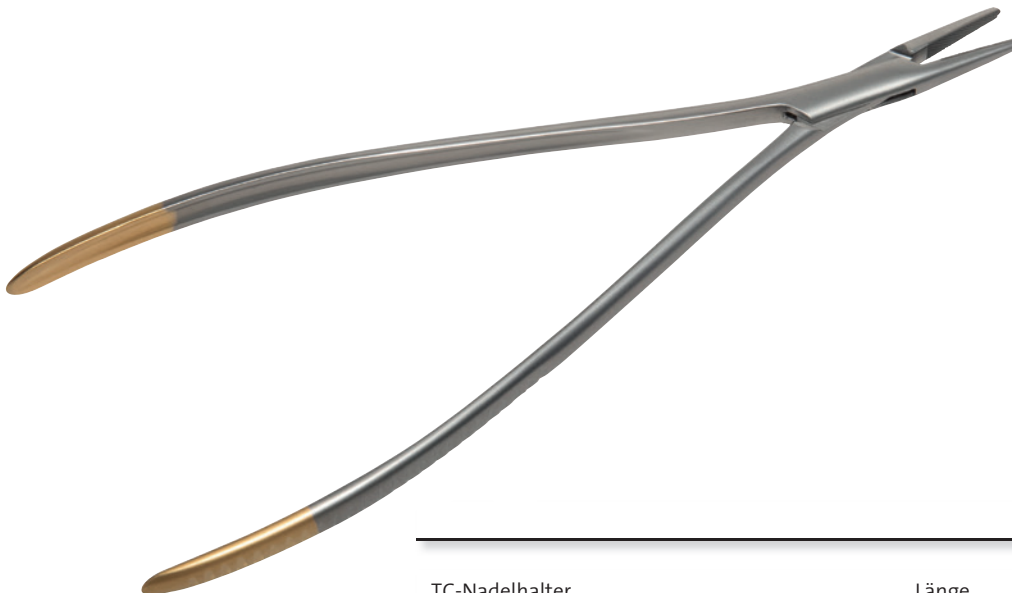

TC-Nadelhalter TC Needle holder	Länge length	Bestell-Nr. Ordering No.
	18 cm / 7 inch	05-127.18

▶ andere Ausführungen und Größen auf Anfrage
other specifications and sizes upon request

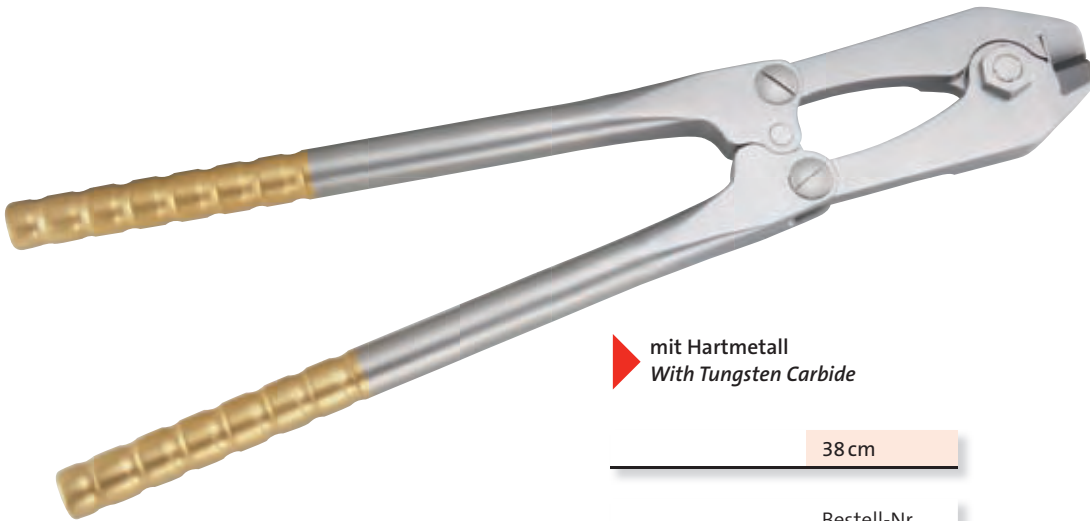

mit Hartmetall
With Tungsten Carbide

38 cm

Bestell-Nr.
Ordering No.

Bolzenschneider
zum Abwicken
von Drähten,
Schrauben und
Nägeln bis zu
4,5 mm Ø
*Cutter for cutting
off wires, bolts,
pins, up to
4.5 mm diam.*

30-110.38

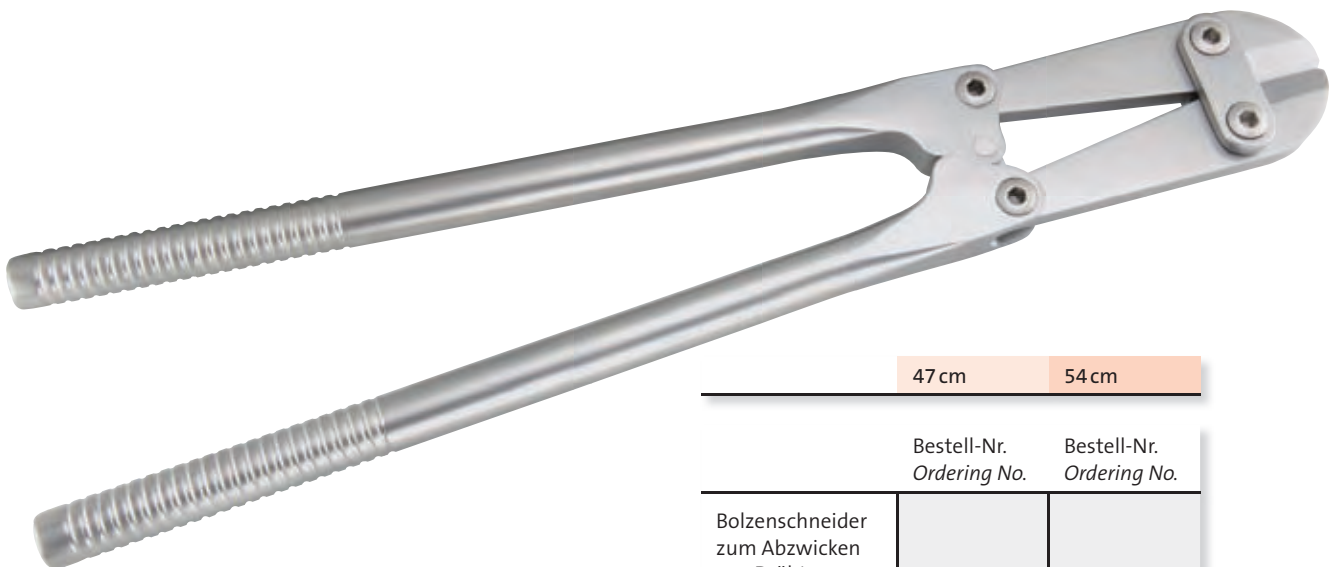

47 cm

54 cm

Bestell-Nr.
Ordering No.

Bestell-Nr.
Ordering No.

Bolzenschneider
zum Abwicken
von Drähten,
Schrauben und
Nägeln bis zu
6 mm Ø
*Cutter for cutting
off wires, bolts,
pins, up to
6 mm diam.*

30-110.50

30-110.60



Orthopädie-Hammer leicht <i>Orthopedic hammer light</i>	Länge <i>length</i>	Bestell-Nr. <i>Ordering No.</i>
	18 cm / 7 inch	95-338.21



Heath-Hammer <i>Heath hammer</i>	Länge <i>length</i>	Kopf <i>head</i>	Bestell-Nr. <i>Ordering No.</i>
	19 cm / 7½ inch	Ø 40mm / 1½ inch	95-335.21



Spongiosa Hohlmeißel <i>Spongiosa Gauge</i>	Länge <i>length</i>	Breite <i>width</i>	Bestell-Nr. <i>Ordering No.</i>
	25 cm / 10 inch	10 mm / 6¼ inch	95-427.10

▶ andere Ausführungen und Größen auf Anfrage
other specifications or sizes upon request

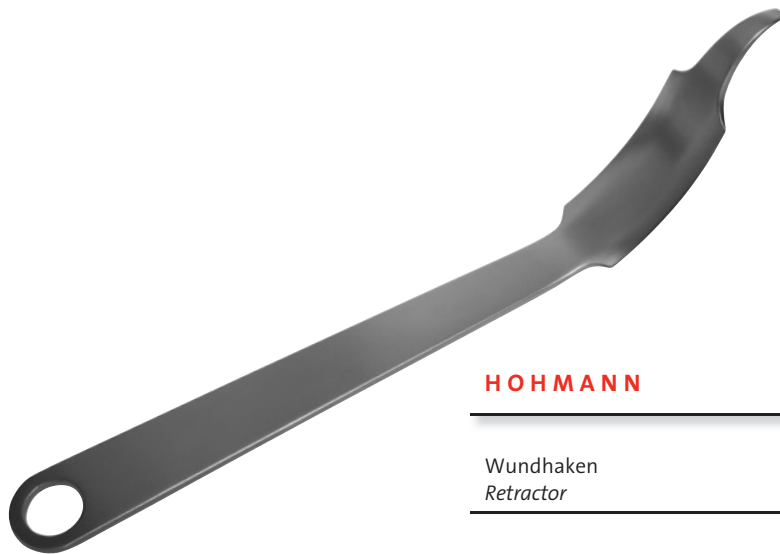

HOHMANN

Wundhaken <i>Retractor</i>	Länge <i>length</i>	Bestell-Nr. <i>Ordering No.</i>
	28 mm / 11 inch	93-051.81

▶ andere Ausführungen und Größen auf Anfrage
other specifications or sizes upon request



HOHMANN

Knochenhebel <i>Bone lever</i>	Länge <i>length</i>	Bestell-Nr. <i>Ordering No.</i>
	24 mm / 9½ inch	95-326.43KM

▶ andere Ausführungen und Größen auf Anfrage
other specifications or sizes upon request

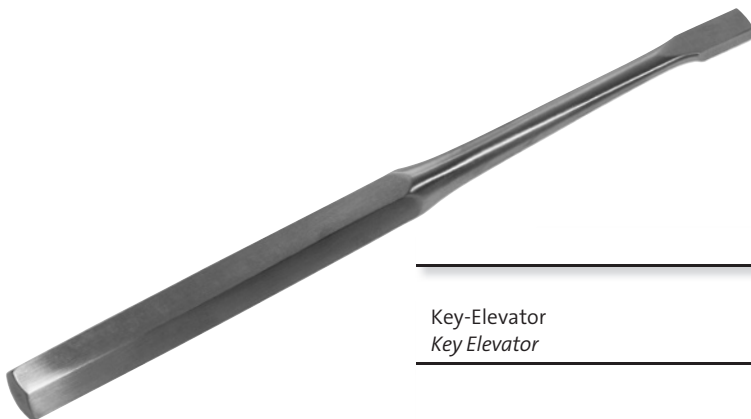

Key-Elevator <i>Key Elevator</i>	Länge <i>length</i>	Bestell-Nr. <i>Ordering No.</i>
	19 mm / 7½ inch	95-512.02KM

▶ andere Ausführungen und Größen auf Anfrage
other specifications or sizes upon request

Surgery . Orthopaedic . Laminectomy



ADDRESS

Hauptstrasse 5
78589 Dürbheim
Germany

CONTACT

Tel. +49 (74 24) 94 03-0
Fax +49 (74 24) 94 03-50

ONLINE

www.kapp-surgical.com
mail@kapp-surgical.com

